

## APPENDIX B - PUBLIC CONSULTATION DOCUMENTS

### - BID

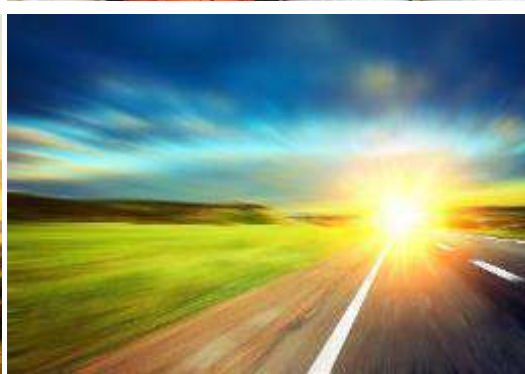

**ECC**  
**ENVIRONMENTAL**  
COMPLIANCE CONSULTANCY



ECC-103-332-NTS-7-A

## **BACKGROUND INFORMATION DOCUMENT**

**TWIN HILLS GOLD MINE PROJECT**

**STAKEHOLDER ENGAGEMENT**

*PREPARED FOR*

***OSINO RESOURCES (PTY) LTD (OSINO GOLD EXPLORATION & MINING (PTY) LTD)***

# **OSINO**

**RESOURCES**

AUGUST 2021

## TABLE OF CONTENTS

<b>1.</b>	<b>PURPOSE OF THIS DOCUMENT .....</b>	<b>3</b>
<b>2.</b>	<b>DESCRIPTION OF PROPOSED PROJECT .....</b>	<b>4</b>
2.1	INTRODUCTION.....	4
2.2	MINE LOCATION & ENVIRONMENT WITHIN THE MINING LICENCE AREA.....	4
2.3	EXPLORATION AND PROJECT PROGRESS .....	4
2.4	WHY IS THE PROJECT NEEDED.....	8
2.5	CONSTRUCTION AND OPERATION PHASES.....	8
<b>3.</b>	<b>CONSIDERATION OF ALTERNATIVES .....</b>	<b>13</b>
<b>4.</b>	<b>THE ENVIRONMENTAL SOCIAL IMPACT ASSESSMENT PROCESS .....</b>	<b>14</b>
4.1	SCREENING.....	16
4.2	SCOPING PHASE.....	18
4.2.1	BASELINE STUDIES .....	18
4.2.2	TERMS OF REFERENCE .....	19
4.2.3	STAKEHOLDER ENGAGEMENT .....	19
4.2.4	SCOPING REPORT .....	19
4.3	ENVIRONMENTAL & SOCIAL IMPACT ASSESSMENT PHASE .....	19
4.3.1	POTENTIAL IMPACTS.....	19
4.3.2	ASPECTS TO BE ASSESSED .....	20
4.3.2	METHODOLOGY (BASELINE STUDIES & ASSESSMENT).....	21
4.3.3	DRAFT ENVIRONMENTAL AND SOCIAL MANAGEMENT PLAN .....	23
<b>5.</b>	<b>THE WAY FORWARD - PUBLIC PARTICIPATION AND ADVERTISING.....</b>	<b>23</b>

**BACKGROUND INFORMATION DOCUMENT**  
**OSINO RESOURCES' TWIN HILLS GOLD MINE PROJECT**  
**KARIBIB DISTRICT, ERONGO REGION, NAMIBIA**

---

**1. PURPOSE OF THIS DOCUMENT**

The purpose of this Background Information Document (BID) is to provide Interested and Affected Parties (I&APs) a background to the proposed project and to invite I&APs to register as part of the Environmental Social Impact Assessment (ESIA) process.

All those who register as an I&AP will be kept informed throughout the ESIA process. Registration provides a platform for participants to submit comments, concerns or recommendations regarding the proposed project.

This BID includes the following information:

- The proposed project and location;
- The necessity of the project, benefits or adverse impacts anticipated;
- The alternatives within the project that will be considered and assessed;
- How the ESIA process works;
- The public participation process and how to become involved; and
- Next steps and the way forward.



## 2. DESCRIPTION OF PROPOSED PROJECT

### 2.1 INTRODUCTION

Environmental Compliance Consultancy (ECC) has been appointed by Osino Resources Corporation (a Canadian registered company) and Osino Namibia Holdings (Pty) Ltd (Holding company of Osino Gold Exploration and Mining (Pty) Ltd) (Namibian registered companies) to act on their behalf for the environmental clearance certificate application for the proposed mining activities for base and rare metals, and precious metals in the Karibib District, Erongo Region, Namibia. The mining project will be commonly known to the public as Twin Hills Gold Project.

Osino Gold Exploration and Mining (Pty) Ltd (hereafter referred to as OGME or The Proponent), is the official applicant for the mining project and environmental clearance application. Previous exploration activities have identified extensive gold mineralization, defined precious metals reserves and resources (especially gold) and extensive development studies which have culminated in a feasibility study and economic analysis for the project, referred to as the Twin Hills Gold Project ("Twin Hills" or "the Project"). Twin Hills is proposed as a conventional truck & shovel open-pit with carbon-in-leach metallurgical processing route which is very similar to the other two gold mines in Namibia, Otjikoto and Navachab. The Twin Hills Gold Project comprises numerous EPL's is rapidly being fast-tracked to development. An important next step is the application for a mining license which will secure the licensing position and tenure of the project, thereby enabling Osino to continue to develop the project into an operational, large-scale gold mine. The planned project involves developing the current exploration activities on EPLs 5196, 6167, 5658, 6953, 3739 and 7301 into full scale gold mining operation. The exploration phase defined the gold ore deposits within the exploration licenses as rendered in the map in **Figure 1**.

In terms of Section 32 (1) of the Environmental Management Act, No. 7 of 2007, ECC has determined that the Ministry of Mines and Energy (MME) is the competent authority for the proposed mining project. The mining activity triggers the listed activities as per the Environmental Management Act Regulations. The relevant activities list provided later in the BID. Environmental Compliance Consultancy (ECC) will undertake an ESIA and draft an Environmental Management Plan (EMP).

### 2.2 MINE LOCATION & ENVIRONMENT WITHIN THE MINING LICENCE AREA

The proposed project is located near the regional town of Karibib ( -21° 55' 59.99" S : 15° 49' 59.99" E) and is approximately 140 km directly northwest of the capital, Windhoek, 32 km east of Usakos, and 66 km south of Omaruru (see **Figure 2**).

The site is accessed via the B2 main road from Windhoek towards Karibib and along the C33 road from Karibib to Omaruru. Images of the various vegetation types and habitats within the mining licence area are rendered below in **Figure 3**.

### 2.3 EXPLORATION AND PROJECT PROGRESS

Osino started prospecting across the deep seated Karibib faultline and during 2019 Osino started developing the Twin Hills Gold Project. This discovery was a result of 18 months of surface geochemical and geophysical exploration that defined a series of targets for shallow percussion drilling. The shallow percussion drilling and diamond drilling confirmed the presence of gold in bedrock. The Twin Hills central discovery is entirely covered with sand and calcrete of an approximate range of 2 – 25m thick. During the 2019 period, a total of 31 drill holes were completed, amounting to approximately 6,000m of drilling. An additional 20,000m of drilling was carried out for 2020, which was sufficient to define a maiden Mineral Resource Estimation (MRE) in early 2021. The Mineral Resource Estimation (MRE) was used to plan further drilling for 2021 and to carry out a Preliminary Economic Assessment (PEA) by July this year.

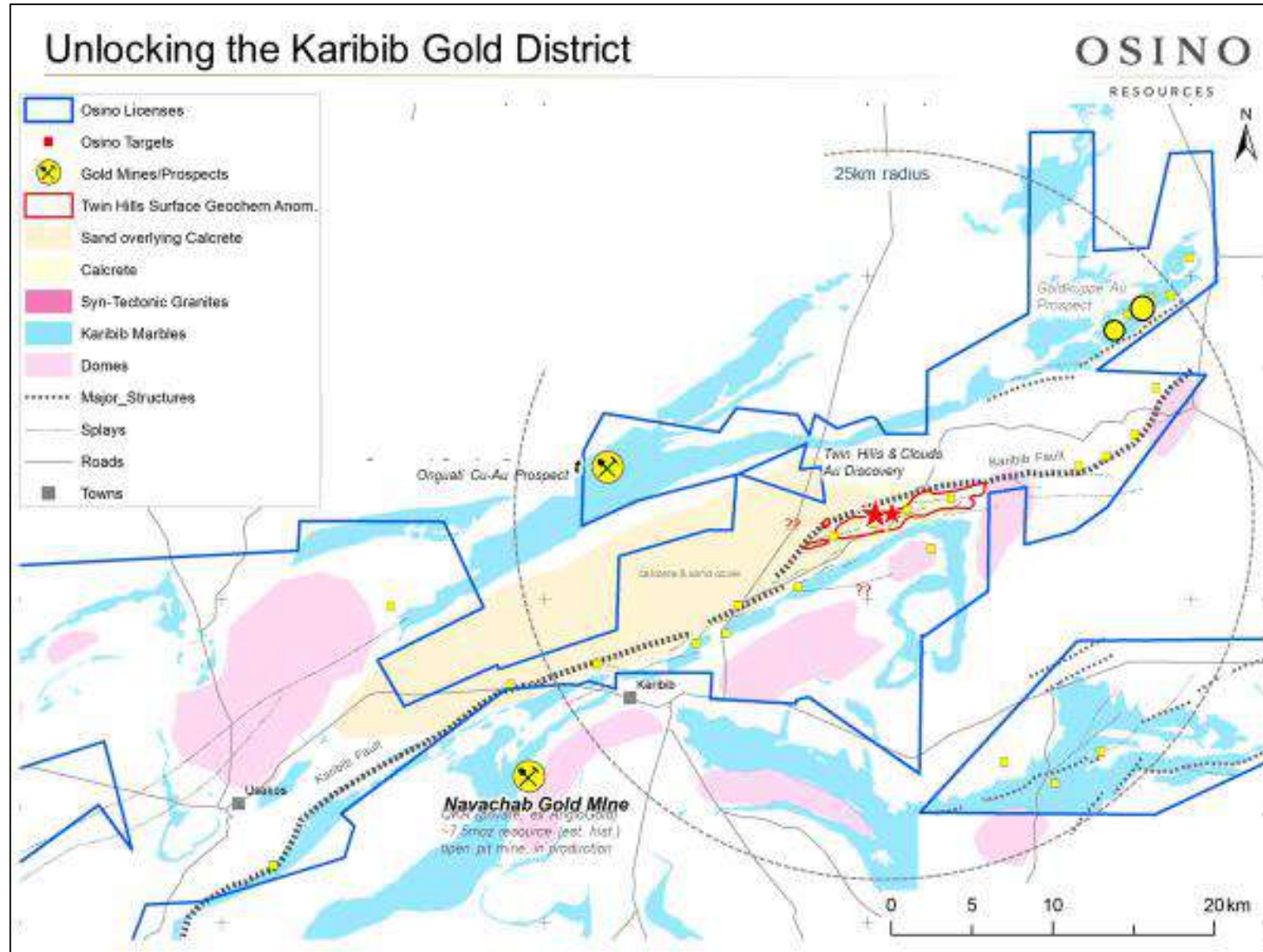

Figure 1. Extent of the Exploration Undertaken by Osino Gold Exploration and Mining (Pty) Ltd

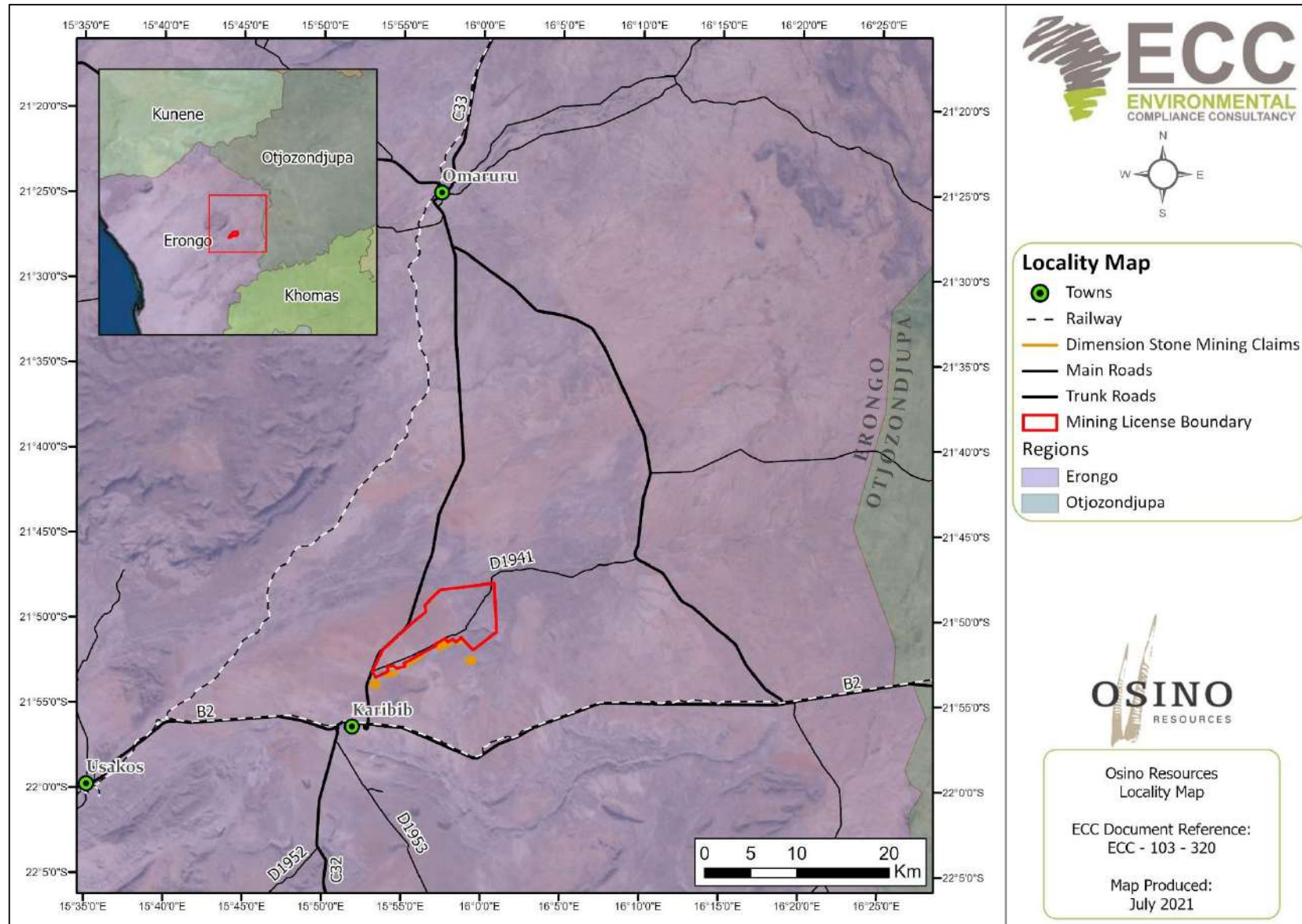

Figure 2. Location Map of the Mining Licence Area



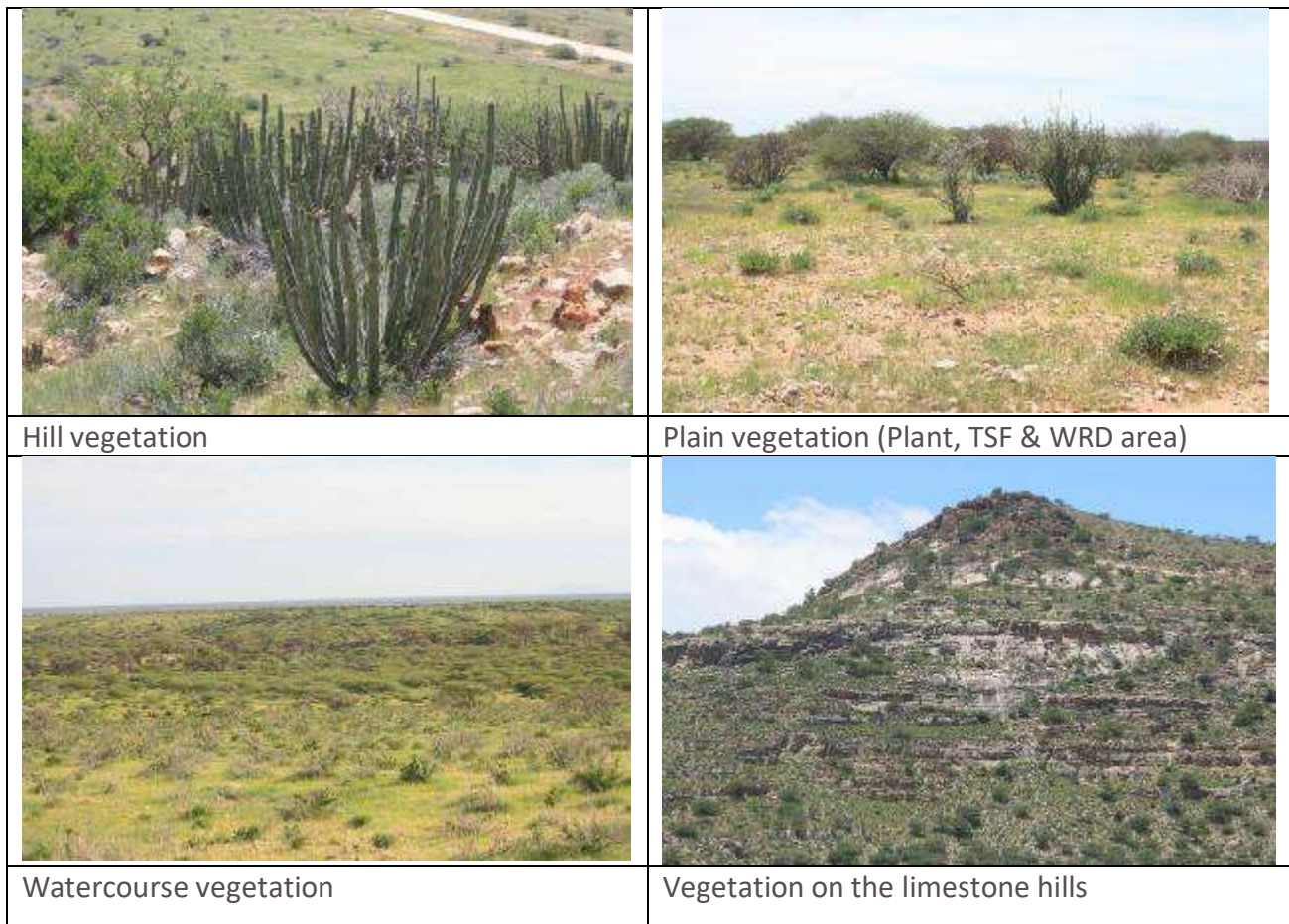

Figure 3. Images of the habitats and vegetation within the mining licence area

## 2.4 WHY IS THE PROJECT NEEDED

Osino intends to pursue mining activities with the aim of retrieving gold out of these new mining prospects. These new mining activities could contribute to the national and local economies. This new mine will have a tremendously positive impact on the country's economy.

## 2.5 CONSTRUCTION AND OPERATION PHASES

It is envisaged that the mining operation at Twin Hills Gold Project will be similar to that of B2Gold Otjikoto and QKR Navachab gold mines. The estimated production at the Twin Hills Gold Mine will be approximately 3 million tonnes of ore which equates to approximately 100,000 ounces of gold per year. The plan and vertical view of the current mining design and resource definition is rendered in **Figure 4**.

Mining of the open pit will be conventional drill and blast, with ore and waste rock being shovelled and transported by a fleet of mobile equipment. Waste rock will be trucked to a waste rock dump, and the ore will be sent to the plant for crushing, cyanide leaching, carbon-in-pulp (CIP) processing, electrowinning and then smelting in an induction furnace to produce gold bars. **Figure 5** renders a chart of the process from mining, processing to mineral waste and final product.

The proposed mining activities are generally high-impact and intrusive. The footprint of the proposed mine licence area is rendered in the map of **Figure 6**. This same map shows the location

of the various site components. The proposed mining licence area will consist of an open pit processing plant that will include a primary- and secondary crusher, a Waste Rock Dump (WRD), and a Tailings Storage Facility (TSF), with the following activities taking place on-site:

- Construction of access tracks and roads, where existing tracks cannot be utilised for the fleet of mobile equipment. The roads are essential due to regular vehicular movement;
- Vegetation clearing for the creation of tracks, open-pit mine and survey access;
- Ongoing ground exploration activities may include soil sampling, geological mapping, geophysical surveys, drilling and drill-core sampling, and blast of the open-pit mine.
- Construction of the plant infrastructure, as well as the infrastructure for fuel and chemical storage;
- Crushing and screening of the ore; and
- Water recycling and dust suppression



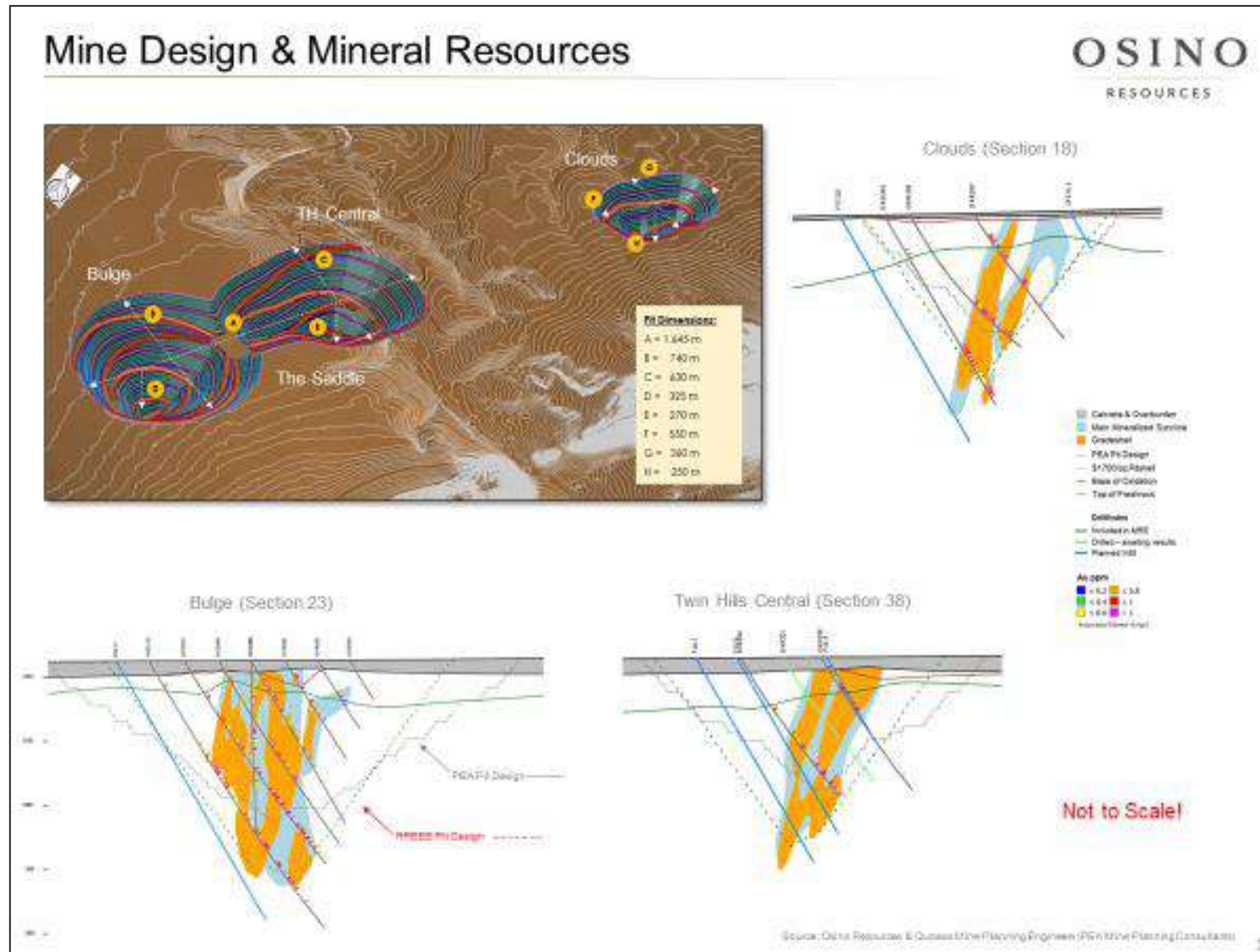

Figure 4. Mining Design and Resource Definition of the Areas within the Mining Licence Area

# Metallurgical Process Plant Layout

**OSINO**  
RESOURCES

Optimal circuit layout is 3-stage crushing followed by ball-milling, pre-oxidation and CIL with electrowinning & smelting. Dry stack tailings deposition (likely co-disposal with waste rock) after detox, thickening & filtration.

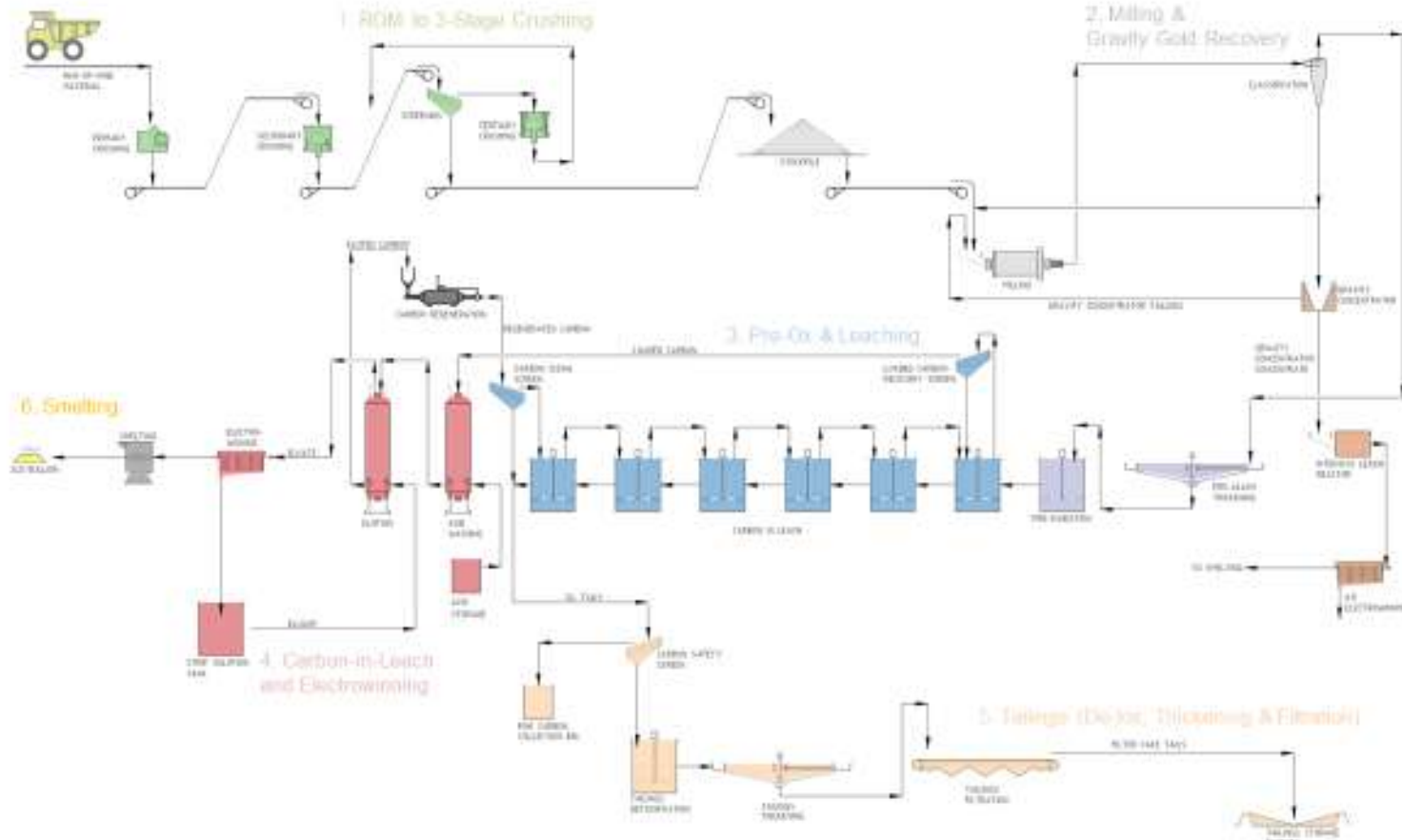

Figure 5. Metallurgical Process Flow from Mining to Product and Mineral Waste

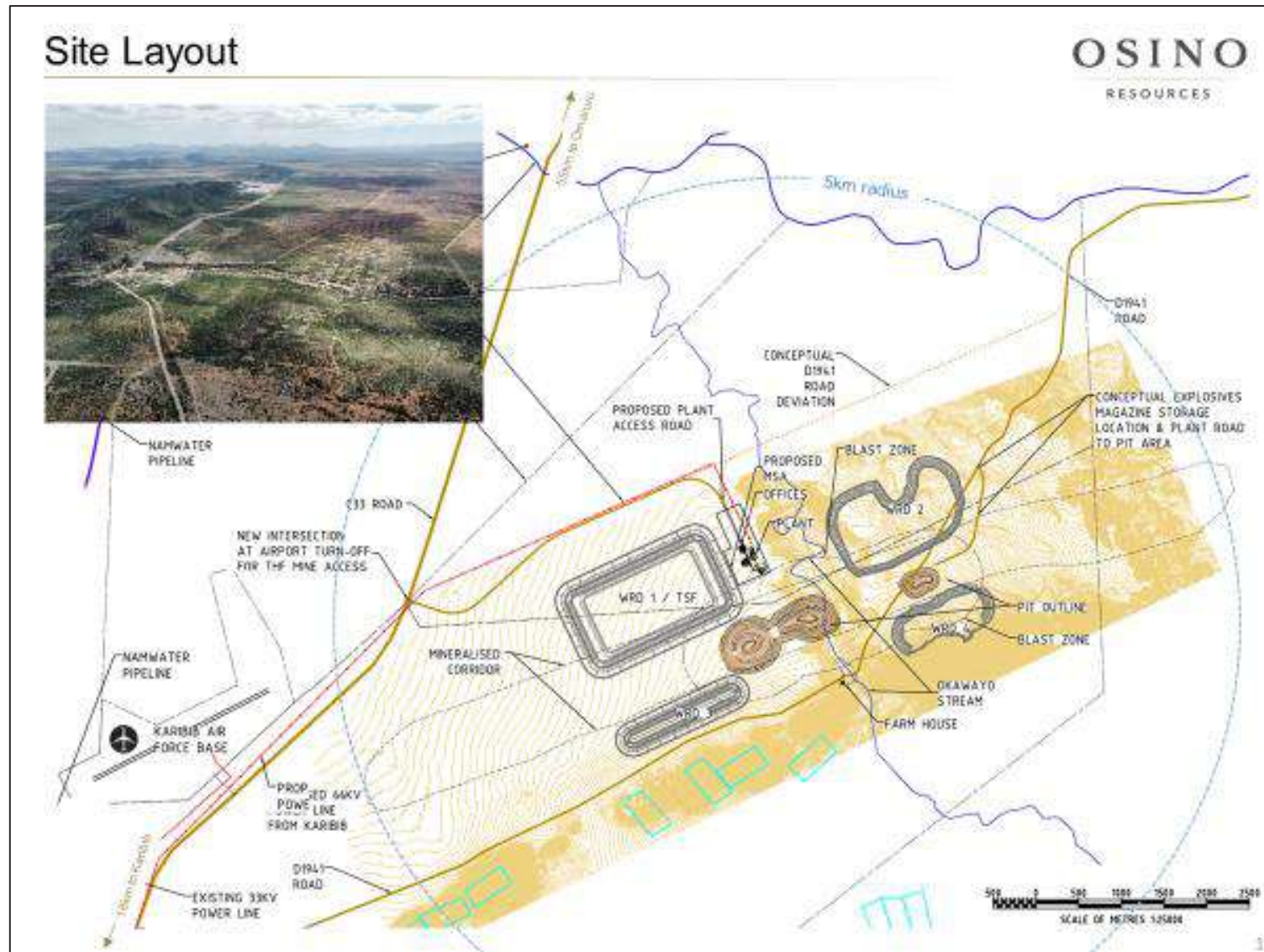

Figure 6. Mine Layout with Linear Infrastructure and Options for Waste Disposal Sites

### **3. CONSIDERATION OF ALTERNATIVES**

Best practice environmental assessment methodology calls for consideration and assessment of alternatives to a proposed project. During the assessment phase, alternatives will be considered and assessed. The alternatives will aim to optimize designs and processes to reduce potential impacts. Here are some aspects where alternatives may be required:

- Different types of technology or operation,
- Route access; and
- Mining methods.

The key aspects that have already been identified where alternatives need to be considered are TSF and WRD locations, alternative plant layouts, tailings deposition techniques, as well as the use of machinery that are not as noisy.



#### 4. THE ENVIRONMENTAL SOCIAL IMPACT ASSESSMENT PROCESS

The ESIA for the proposed project is being conducted by ECC and was undertaken in terms of the Environmental Management Act, 2007 and its regulations. The process followed for this ESIA is set out in the flowchart in Figure 7.

Osino currently holds the following Exclusive Prospecting Licences (EPLs) with approved Environmental Management Plans (EMPs):

**Table 1. EPL licence periods**

LICENCE	STATUS
EPL 5196	09/04/2014 to 08/04/2021
EPL 6167	23/02/2017 to 22/02/2022
EPL 5658	23/09/2014 to 19/10/2022
EPL 6953	13/06/2018 to 12/06/2021
EPL 3739	11/09/2011 to 15/05/2021
EPL 7301	12/11/2020 to 11/11/2023

The planned mining licence area for the Twin Hills Gold Mine lies mainly within EPL 7301. Exploration will continue within all of the EPLs with the potential that mining will extend to these EPL areas if viable resources are discovered. ECC has been commissioned by Osino as the independent Environmental Assessment Practitioner (EPA) to facilitate the whole ESIA process.

Prior to the start of the proposed mining project, environmental clearance is required in terms of the Environmental Management Act, 7 of 2007 and the associated EIA Regulations. A final decision relating to the above-mentioned application will be made by MEFT: Department of Environmental Affairs (DEA). The related environmental process will include:

1. Screening phase (completed);
2. Scoping phase which includes baseline studies and the development of the Terms of Reference (ToR) for the ESIA (initiated);
3. Assessment Phase which includes impact prediction and evaluation of alternatives, assigning mitigation measures and developing monitoring and conceptual rehabilitation plans. This phase culminates in the drafting of the ESIA report and draft Environmental Management Plan (EMP) and submission to the appropriate competent authorities.

In simple terms, the main objectives of the ESIA are to:

- Provide information describing the planned Twin Hills Gold Mine project and associated activities;
- Provide an independent environmental assessment of the activities associated with the proposed mining project; and
- Develop management and mitigation measures associated with any identified potential impacts where necessary.

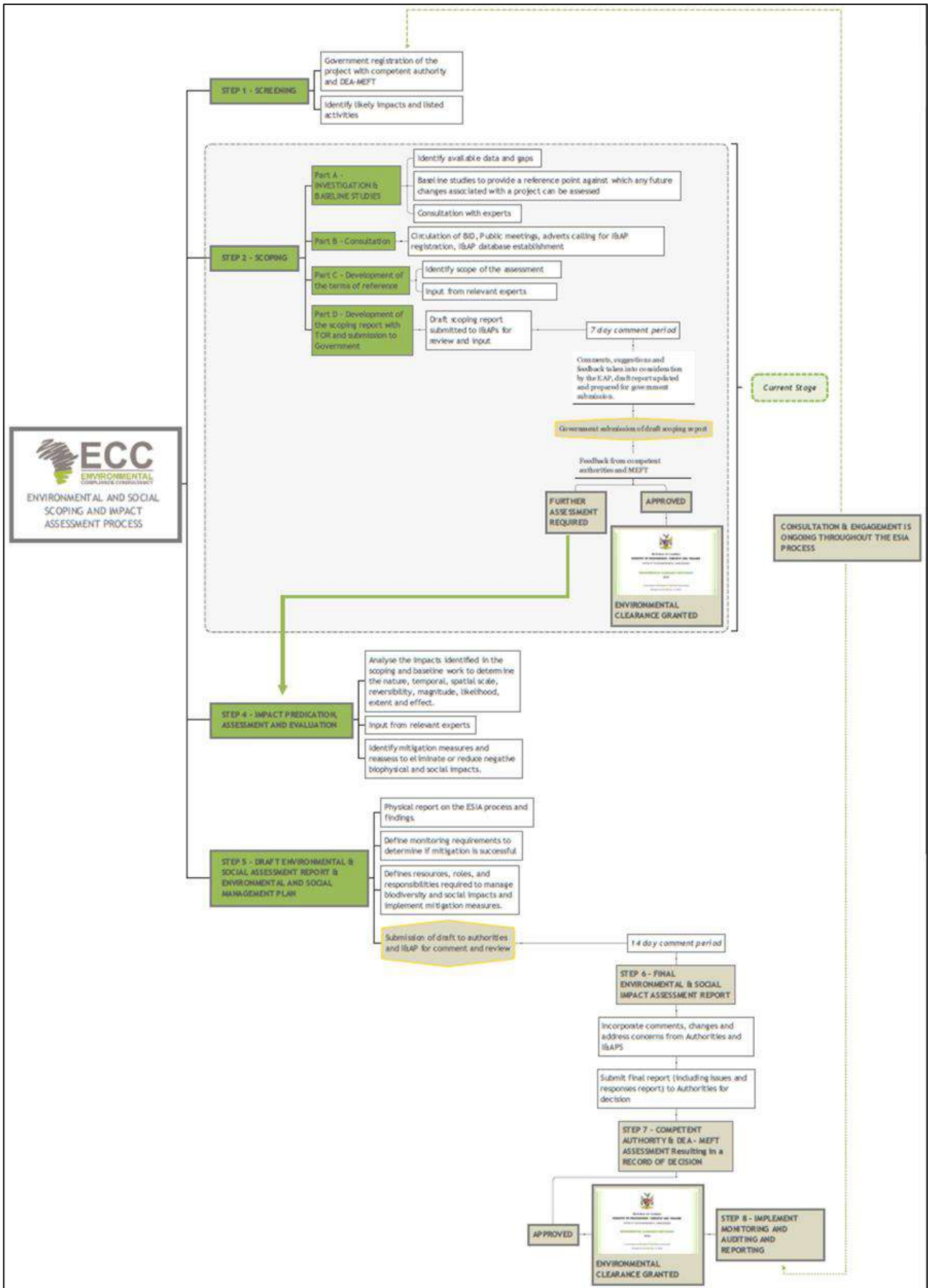

Figure 7. Flowchart of the Environmental Assessment Process



#### 4.1 SCREENING

A review of the planned project was undertaken and the screening findings against the listed activities was conducted; the findings of which are summarised below:

TABLE 1: LISTED ACTIVITIES TRIGGERED BY THE PROJECT INCLUDE:

LISTED ACTIVITY	EIA SCREENING FINDING
<p><b>ENERGY GENERATION, TRANSMISSION AND STORAGE ACTIVITIES</b></p> <p>(1.a) The construction of facilities for the generation of electricity.</p> <p>(1.b) The construction of facilities for the transmission and supply of electricity.</p>	<ul style="list-style-type: none"> <li>– The mine will connect to the Nampower grid.</li> <li>– There is a possibility that a solar power station will be constructed for the generation of electricity.</li> <li>– The electricity that is generated will be used to supply electricity to the mine and potential surplus redirected into the grid power system.</li> </ul>
<p><b>WASTE MANAGEMENT, TREATMENT, HANDLING, AND DISPOSAL ACTIVITIES</b></p> <p>(2.1) The construction of facilities for waste sites, treatment of waste and disposal of waste.</p> <p>(2.2) Any activity entailing a scheduled process referred to in the Atmospheric Pollution Prevention Ordinance, 1976.</p> <p>(2.3) The import, processing, use and recycling, temporary storage, transit or export of waste.</p>	<ul style="list-style-type: none"> <li>– Facilities for disposal of waste generated by site will need to be constructed.</li> <li>– The activity that is listed in the Environmental Management Act, No. 7 of 2007 (2.2) referred to (58) in the Atmospheric Pollution Prevention Ordinance, 1976. The bulk storage and handling of ore: That is to say, the storage and handling of metallic ore at dumps designed to hold 100 000 metric tons or more, which are not situated on the premises of a mine or works as defined in the Mines, Works and Minerals Ordinance, 1968 (Ordinance 20 of 1968).</li> </ul>
<p><b>MINING AND QUARRYING ACTIVITIES</b></p> <p>(3.1) The construction of facilities for any process or activities which requires a license, right or other form of authorization, and the renewal of a license, right or other form of authorization, in terms of the Minerals (Prospecting and Mining Act), 1992.</p> <p>(3.2) Other forms of mining or extraction of any natural resources whether regulated by law or not.</p> <p>(3.3) Resource extraction, manipulation, conservation and related activities.</p>	<ul style="list-style-type: none"> <li>– This listed activity, infers the provisions of the Minerals Act (Prospecting and Mining) Act 33 of 1992, under different licences as the basis upon which certain activities qualify for an EIA. The Minerals Act (1992) defines mining activities under the lawful ownership of a mining licence (ML). A mining licence includes any mining activities.</li> <li>– The resource in this case gold, will be extracted, then processed in the plant eventually producing gold bars.</li> </ul>
<p><b>FORESTRY ACTIVITIES</b></p>	<ul style="list-style-type: none"> <li>– Vegetation clearing may be required for</li> </ul>

LISTED ACTIVITY	EIA SCREENING FINDING
<p>(4) The clearance of forest areas, deforestation, a forestation, timber harvesting or any other related activity that requires authorisation in term of the Forest Act, 2001 (Act No. 12 of 2001) or any other law.</p>	<p>tracks and the construction of access roads, and possibly for the setup of the, thickener, filter press and disposal facility of tailings.</p>
<p><b>WATER RESOURCE DEVELOPMENT</b></p> <p>(8.1) The abstraction of ground or surface water for industrial or commercial purposes.</p> <p>(8.2) The abstraction of groundwater at a volume exceeding the threshold authorized in terms of a law relating water resources.</p> <p>(8.4) Construction of canals and channels including the diversion of the normal flow of water in a riverbed and water transfer schemes between water catchments and impoundments.</p> <p>(8.5) Construction of dams, reservoirs, levees and weirs.</p> <p>(8.6) Construction of industrial and domestic wastewater treatment plants and related pipeline systems.</p> <p>(8.9) Construction and other activities within a catchment area.</p>	<ul style="list-style-type: none"> <li>– Ground and surface water may be abstracted, or sourced for the operation.</li> <li>– The sourced groundwater may likely exceed the threshold authorized in terms of the Water Act, and therefore permits for abstraction must be sourced.</li> <li>– An ephemeral river runs through a section of the planned open-pit, thus a strategy is required to assess the management of this potential interaction.</li> <li>– There is a possibility of the construction of a dam and the water will be used for the plant.</li> <li>– Pipeline systems will need to be constructed to transport the water to the plant from the dam.</li> <li>– The mining area is within a catchment area.</li> </ul>
<p><b>HAZARDOUS SUBSTANCE TREATMENT, HANDLING AND STORAGE</b></p> <p>(9.1) The manufacturing, storage, handling or processing of a hazardous substance defined in the Hazardous Substances Ordinance, 1974.</p> <p>(9.2) Any process or activity which requires a permit, licence or other form of authorization, or the modification of or changes to existing facilities for any process or activity which requires amendment of an existing permit, licence or authorization or which requires a new permit, licence or authorization in terms of a governing the generation or release of emissions, pollution, effluent or waste.</p>	<ul style="list-style-type: none"> <li>– The storage, handling and processing of the hazardous substances including cyanide that will be required in the processing plant.</li> <li>– Licences will be obtained for all hazardous substances that will need to be stored on the site.</li> <li>–</li> </ul>

LISTED ACTIVITY	EIA SCREENING FINDING
(9.4) The storage and handling of a dangerous goods, including petrol, diesel, liquid petroleum gas or paraffin, in containers with a combined capacity of more than 30 cubic meters at any one location.	
<p><b>INFRASTRUCTURE</b></p> <p>(10.b) The construction of public roads.</p> <p>(10.g) The construction of communication networks including towers, telecommunication and marine telecommunication lines and cables.</p> <p>(10.j) i) The construction of masts of any material or type and of any height, including those used for telecommunication broadcasting and radio transmission, but excluding flag poles; and ii) Lightning conductor poles.</p>	<ul style="list-style-type: none"> <li>– A new road may need to be constructed from C33 to D1941, as road D1941 is currently located in the center of the proposed open-pit area.</li> <li>– Towers for communication will need to be constructed, thus cables and telecommunication lines will be put in place.</li> </ul>

## 4.2 SCOPING PHASE

The scoping phase is important because in this phase the potential impacts that may have significance to the biophysical and social environments are identified. The appropriate available data and gaps in the literature are identified forming the starting point for the baseline studies.

### 4.2.1 BASELINE STUDIES

For the proposed project, baseline information will be obtained through desk-based studies and site verification. The ESIA will focus on the environmental receptors that could be affected by the proposed project. ECC will also engage with stakeholders, I&APs and the proponents to seek input into the assessment. The baseline studies chapter is broken into three sections, the baseline context, environmental (physical and biological), and social (includes economic). Baseline context includes information on the location and the reasoning behind why the proposed project area was chosen. Desktop studies, field surveys and specialist studies will be used to collect data for the project. The baseline studies also give a further indication whether is any local or regional future developments that could impact the project or the impacts the project can have on the environment. The baseline context also helps receive information on uncertainties, limitations and assumptions one might have.

The baseline section for the biophysical environment focuses on eight specific topics, these topics includes: topography, hydrology and drainage patterns (surface water, groundwater, rivers, etc.), geology and soil classification, climate and meteorology, land use, landscape and visual amenity,

Terrestrial biodiversity and ecology (flora, fauna, amphibians, reptiles, avifauna, mammals) and habitat mapping.

Lastly the socio-economic section of the baseline studies helps to gain information on the governance, demographic profile, social stratification (employment, education, crime, infectious disease), occupation and livelihood (economic activities, occupations in study area, employment rates), land patterns (cultural heritage, air quality, noise and vibrations) and access to services (drinking water, sanitation, healthcare facilities etc.).

#### 4.2.2 TERMS OF REFERENCE

Based on the stakeholder engagement through public meetings and written correspondence, and the baseline studies, the ToR for the impact assessment will be fixed.

#### 4.2.3 STAKEHOLDER ENGAGEMENT

The general public and key stakeholders receive invitations to register as I&APs. After the presentation of the mining project and ESIA process at the public meetings a period of input will be granted for the Environmental Assessment Practitioner (EAP) to receive any additional concerns or comments. All feedback from the initial consultation will be incorporated into the scoping report.

#### 4.2.4 SCOPING REPORT

The scoping report will be drafted and submitted to the registered I&APs for comment before being submitted to the competent authority and MEFT to inform them of the impact assessment process that will proceed. The scoping report will contain a description of the project and the bio physical and socio-economic environment, the specialist baseline studies, stakeholder engagement report and the terms of reference for the ESIA.

### 4.3 ENVIRONMENTAL & SOCIAL IMPACT ASSESSMENT PHASE

#### 4.3.1 POTENTIAL IMPACTS

The potential social and economic impacts that have been anticipated may include the following:

- Potential to unearth, damage or destroy undiscovered heritage remains;
- Potential relocation of farm residents;
- Potential regular disruptions (dust and noise) to the residents of the farms near mining site;
- Potential job creation due to the proposed project;
- Potential influx of people moving to the Karibib and Omaruru areas;
- Potential social nuisances;
- Potential regional and national economic benefits; and
- Potential increase in traffic passing and entering the mine site.

The potential environmental impacts that have been anticipated may include the following:

- Potential use of local water resources, including surface water and groundwater;
- Potential realignment of surface stream that runs through the mine site;

- Potential soil and groundwater contamination from hydrocarbon, chemical or acid mine drainage from the mining activities;
- Potential pollution of the atmosphere due to dust fallout;
- Potential biodiversity impacts and habitat alteration or loss (eg. vegetation clearing and subsequent mining activity footprint);
- Potential realignment of the existing district road;
- Potential change in landscape aesthetic value and sense of place; and
- Potential noise and vibration impacts.

#### 4.3.2 ASPECTS TO BE ASSESSED

The following potential issues are identified and described as requiring assessment:

Aspect	Describe, Analyse, Assess Impact
Fauna and Flora	<ul style="list-style-type: none"> <li>- Large and small mammal transects to determine mammal diversity in the area;</li> <li>- Reptile &amp; amphibian transects (diurnal &amp; nocturnal) to determine reptile &amp; amphibian diversity in the area;</li> <li>- Bird transects to determine avian diversity in the area; and</li> <li>- Flora transects to determine plant diversity in the area and the impact the mine will have on the biodiversity.</li> </ul>
Ground water	<ul style="list-style-type: none"> <li>- Impact of dewatering the mine pit on groundwater levels.</li> <li>- Impact of hydrocarbon pollution from equipment and mining processes.</li> <li>- Impact of groundwater abstraction from production borehole on local groundwater levels.</li> </ul>
Surface water	<ul style="list-style-type: none"> <li>- Surface water resources pollution.</li> <li>- Modification of natural drainage patterns and flow: Stormwater decrease.</li> </ul>
Air Quality	<ul style="list-style-type: none"> <li>- Air pollution, dust irritation and amplified risk of health impact to third parties.</li> <li>- Identification of air pollution sources of pollution within the project area;</li> <li>- Identification of sensitive receptors in the vicinity of the project;</li> <li>- Analysis of collected air quality data; (ECC has a dataset (dust and weather) that is to be used that has been collected monthly)</li> <li>- Assessment of future areas of concern due to the project using dispersion modelling;</li> <li>- Evaluation of predicted pollutants concentration against regulatory standards;</li> <li>- Assess predicted levels against the IFC air quality guidelines</li> </ul>

Aspect	Describe, Analyse, Assess Impact
	to determine compliance; and – Based on the information, the impacts will be assessed, and mitigation and management measures will be recommended.
Noise	– Noise disturbance to third parties – Noise measurements will be carried out at key noise receptors. – All measurements are to be taken in accordance with the relevant noise regulations as well as the IFC Noise Management guidelines.
Traffic	– Impact on third party road users. – Impact on the Karibib airport that is located close to the mine, the impact on the air traffic of the airport.
Visual	– Decreased visual resources for residents, recreational users, hunters and C33 and B2 road users.
Socio-Economic	– Economic impacts – Job creation and skills development – In-migration to Usakos, Omaruru and close neighbourhood such as Karibib – Community security and health
Cultural heritage	– Primary data should be collected during a pre-disturbance survey. This survey is to be conducted for the site specific study area. – The site survey should include surveying the proposed project footprint areas and potential alternative layouts.

#### 4.3.2 METHODOLOGY (BASELINE STUDIES & ASSESSMENT)

As most impact assessments require standard baseline studies, it was the professional opinion of the EAP to initiate studies prior to the public consultation phase. Baseline studies for flora, fauna, air quality, noise, traffic, water resources and heritage (archaeology) were commissioned. The draft reports are currently being reviewed by the EAP.

The methods that were used to determine the biodiversity of the fauna and flora for the proposed area include the following: small mammal trapping was conducted by active trapping using collapsible Sherman traps. Small mammals caught were identified *in situ*, photographed, measured (when applicable to facilitate identification) and released unharmed at the site of capture. The larger mammal presence was determined by direct observations including other signs – e.g. tracks, scats, carcasses, burrows, scrapes, etc. Camera traps were set to capture



images of larger mammals in the area (if feasible). Reptile and amphibian transects were conducted during the day and night (using a gas lantern) to determine the diurnal & nocturnal reptile diversity. Reptiles & amphibians were caught using active capture technique ('reptile noosing') and identified *in situ*, photographed, measured (when applicable to facilitate identification) and released unharmed at the site of capture. Bird transects (on foot & by vehicle) were conducted during daylight hours using binoculars to ID and confirm species. The flora diversity to determine species composition was conducted using the step point method. Tree and shrub densities were determined using standard quadrates (10x10m or 20x20m – depending on the terrain (or as recommended by the specialist). Focus was on the identification of unique species in the proposed development area. Samples were collected for further identification when found to be necessary.

The methods used to determine the air quality of the proposed area included the following: Using baseline data collected on site over the past 8 months. Modelling predicted changes to air quality.

The methods that were used to determine the noise disruption within the mining area included the following: the objective of the environmental noise impact assessment will be to identify whether the noise levels from the mining activities will impact on surrounding receptors as per the IFC EHS Environmental Noise Management Standards. The results of the noise dispersion modelling will be compared to the relevant regulations to establish site thresholds. The baseline study included receptor identification and baseline noise measurements. The assessment phase includes impact quantification by means of noise dispersion modelling, and mitigation and noise control recommendations.

The methods that are used to determine the heritage of the proposed area included the following: The heritage baseline survey required compliance with Namibian national legislature, including the National Heritage Act, 2004 (Act No 27 of 2004) and the National Heritage Regulations, Government Notice (GN) 3490 of 2005. Likewise, the proposed assessment process will comply with these requirements which are also encapsulated in the IFC Performance Standard 8 Cultural Heritage.

The baseline study identified potentially significant heritage resources, as defined in Part I of the National Heritage Act, 2004. This was done through fieldwork and desktop research. Recommendations and propositions for the management or mitigation of the potential impacts will be reported on during the assessment phase.

Impacts will be assessed using the EAP's ESIA methodology. The ESIA is being conducted in terms of the Environmental Management Act, 2007 and its regulations. The EAP's methodology for impact assessments was taken from the IFC standards, in particular Performance Standard 1 'Assessment and management of environmental and social risks and impacts' (IFC 2012, 2017). The Namibian Draft Procedures and Guidance for ESIA and EMP (GRN, 2008) are also being applied. The EAP will implement international and national best practice and has over 25 years of combined ESIA experience.

In conclusion the environmental aspects and potential impacts of the planned Twin Hills Gold Mine and the associated activities will be identified and evaluated. For the most part the baseline studies provide the baseline conditions for the various environmental aspects. Where no baseline data exists the EMP will outline the aspects that need to be measured prior to construction.

#### 4.3.3 DRAFT ENVIRONMENTAL AND SOCIAL MANAGEMENT PLAN

An EMP shall be developed for the mining project setting out auditable management actions for the project to ensure careful and sustainable management measures are implemented for their activities in respect of the surrounding environment and community. The EMP becomes the legally binding commitments upon approval of the EMP and issuing of the clearance certificate.

### 5. THE WAY FORWARD - PUBLIC PARTICIPATION AND ADVERTISING

To re-iterate, public participation is an important part of the ESIA process. It allows you, the public and stakeholders to raise concerns or provide valuable local environmental knowledge that can benefit the assessment process as well as aid the planning process. This project is currently at the scoping phase which includes the first phase of public engagement.

At this phase ECC will perform the following:

- Identify key stakeholders, authorities, municipalities, environmental groups and interested or affected members of the public, hereafter referred to as I&As;
- Distribute the BID for the Twin Hills Gold Mine project (this document);
- Advertise the environmental application in two national newspapers (completed);
- Place notices on-site at or near the boundary;
- Host public meetings to encourage stakeholder participation and engagement, and provide details of issues identified by the environmental practitioner, stakeholders and I&As
- Record all comments of I&As and present such comments, as well as responses provided by ECC, in the comments and responses report, which will be included in the scoping report that shall submitted with the application, and
- Circulate I&A comments to the project team for consideration of project design.

Comments must be submitted in writing and can be emailed using the details in the contact us section below. Verbal comments at public meetings will also be recorded.

Please provide initial comments or concerns in writing by the 24<sup>th</sup> September 2021.

## CONTACT US

We welcome any enquiries regarding this document and its content. Please contact:

**Environmental Compliance Consultancy  
(ECC)**

[info@eccenvironmental.com](mailto:info@eccenvironmental.com)

Tel: +264 816 697 608

[www.eccenvironmental.com](http://www.eccenvironmental.com)

At ECC we make sure all information is easily accessible to the public.

Follow us online to be kept up to date:

## - NEWSPAPER PUBLICATIONS

The Namibian newspaper advert, 18th and 25th of August 2021

**16 WEDNESDAY 18 AUGUST 2021**

**OPPORTUNITIES**

**Job Title : Metallurgical Engineering Graduate**  
**Department : Namibia (Rosh Pinah)**  
**Reporting To : Country Manager**

**Minimum Qualifications:**

- University Degree
- University results – Average 80% or higher

**Key Functions:**

- Assist/Conduct Trials
- Writing of Case Studies
- Build and grow professional network
- Support sales network in technical capacity
- Provide market intelligence
- Compile tenders and quotations
- Field service support on pumps
- Technical product presentations to customers
- Compile technical reports
- Understand and interpretation of technical drawings
- Grow Product install base in Africa
- Salesforce Pipeline Management
- Adhere to all SHE and housekeeping requirements
- Adhere to Duty of Care Policy at all times

**Minimum Skills / Abilities:**

- Relevant computer skills (MS Office)
- Planning and organising skills
- Adaptability/ Flexibility
- Ability to cope under pressure
- Good business communication
- Problem solving skills

**Required Documents:**

- Detailed CV/Resume
- Copy of Identity Document
- Copy of University Degree
- Detailed statement of academic results

Interested candidates who meet the above minimum requirements are invited to submit their detailed CV application with proof of qualifications to [za001.graduatesas@mcw.net](mailto:za001.graduatesas@mcw.net) by 27 August 2021

**WE ARE AN EQUAL OPPORTUNITY COMPANY**

If you have not heard from the Company 10 working days after the closing date, please accept that your application was unsuccessful.

**Effective Date: 20 August 2021**      **Expiry Date: 27 August 2021**

**Authorised By: Bathabile Mosala**

---

**Case no AC 10/2019**

**IN THE HIGH COURT OF NAMIBIA**  
(Exercising its Admiralty Jurisdiction)

Name of Vessel: **MFV "PESCAMARO DOS"**

In the matter between:

**WESTMARINE INDUSTRIAL SUPPLIES CC**      **Applicant**

and

**THE MFV "PESCAMARO DOS" HER OWNERS AND ALL OTHERS INTERESTED IN HER**      **Respondent**

---

**ABBREVIATED ORDER OF COURT**

**KINDLY TAKE NOTICE** that on **Friday, 06 August 2021**, the above honourable Court issued a Rule Nisi calling on all persons interested to show cause before this High Court on **Friday, 3 September 2021** at 10:00 or as soon thereafter as the matter may be heard why an Order in the following terms should not be made:

1. That the MFV "PESCAMARO DOS" (hereinafter referred to as "the vessel") be sold by public auction subject to confirmation by the Court.
2. That the Deputy Sheriff for the district of Walvis Bay act as auctioneer for and on behalf of the Court in respect of the sale. The contact particulars of the auctioneer are as follows:  
Tel number: 00 264-64-221 805  
Fax number: 00 264-64- 221 806  
Cell: number: 00 264 (0) 81 280 1899  
Reference: Mr Andre Visser
3. That Advocate Jan Albert Nicolaas Strydom be appointed as Referee to receive, examine, consider and report to this Honourable Court upon the validity and rankings of claims against the Fund.
4. That the sale shall be held not less than two (2) weeks and not more than four (4) weeks after the return date for the confirmation of this order.
5. That the auctioneer shall advertise the sale and the date thereof not less than five (5) calendar days before the sale once in the "Namib Times" in Namibia and once in an international shipping publication, being one of Lloyds List, Tradewinds or Fairplay.
6. That the proceeds of the sale shall constitute a Fund in the High Court of Namibia and shall be dealt with in accordance with the provisions of the order.

That the full text of the order and the conditions of sale are both available for inspection at the applicant's legal practitioners, Dr Wedder, Kautz & Hoveka Inc, Maritime Building, Theo-Ben-Gurrah Street, Walvis Bay, Republic of Namibia (Ref. Mr D. Malherbe), telephone number: 00264-64-211890 email [dmalherbe@wkh-law.com](mailto:dmalherbe@wkh-law.com)

**DATED at WINDHOEK on this 6th day of AUGUST 2021.**

**REGISTRAR OF THE HIGH COURT OF NAMIBIA**

**mOshiwambo**      **THE NAMIBIAN**

# Opolohalama yiikulya poosikola ya yiwa moshipala kocorona



**Sarret Steenkamp**

ASHIKE aana yamwe ohaya lombwele aalongi kutya, kosikola ihaye ya ko oshoka kaye na shoka taya li," osho a popi ngaaka.

Andreas Katangoio, omukuluntuwikili posikolandioka okwa popi kutya komina hambala yomvula sho osikola dha patuluka, onkene osikola yawo taya nyengwa okuhawhawemka aana ya tsikile notundi.

"Opolohalama okwa li ya kalekwa omotwokwaana owino ya nkene omukithi ngoka hagu taandele. Ashike nando ongauka shoka okwa li sha ningwa meendelelo naanona kaya li yu uviteko shoka sha holoka po. Oya kala ashike ya tega okupewa ikulya, ashike kasha li we tashi ningwa. Okwa li lela tashi etitha ohenda," osho a popi ngaaka.

**OPOLOHALAMA INAYI ZA PO**

Omukuluntuwikili muaministili welongo, uunkulungu nomithigulihwakalo, Sarret Steenkamp, okwa popi kutya oshimaliwa shi li poomiliyona N\$95 osha gandjwa kopolohalama yiikulya yoposikola okwa kepangelo, onkene opolohalama ndjoka inayi huithwa po thulu.

Steenkamp okwa popi kutya epato lyosikola omolwombuto yocorona moshilongo, oye etitha opolohalama yokegandjwa iikulya poosikola yi kalekwa.

"Ashikenandoongaka, osikola osha gandja epungu kaanona oyendji mbokata yana nondatu oyo ya ka lye komagumbo. Egan-djo lyashoka oya ningwa kwi ikwatelela kuusita mboka wa li po pethimbo osikola ya pata," osho Steenkamp a popi ngaaka.

Okwa popi kutya opolohalama ndjoka inayi huithwa po thulu.

"Osikola adhibe ndhoka dha shangithwa nopolohalama onkene tadhipewai iikulya. Ngele opolohalama ndjoka oya katekwa ngika omokulanda iikulya nenge pambe ya tokelwa omolwomalongekidho goka yi thikitha [posikolaj]," osho a popi ngaaka.

Steenkamp okwa popi kutya ngashingeyi uuministili welongo, uunkulungu nomithigulihwakalo, otawu lalakanene okwe eta po omulandu gwiikumino posikola opepe yi tameke okweta po sha shoka tashi vula okwa adha ondjilakati opolohalama yiikulya posikola.

"Otatu tu omukumo kehe osikola yi kale yi na oshikunimo moka tamu kala nokukumina iikulya nenge ikwamboga mbyoka taya kala nokugwedhakanithwa nopolohalama yiikulya."

\*Kageshi omadhina gawo golola

**OSINO RESOURCES**

**NOTICE OF AN ENVIRONMENTAL ASSESSMENT AND PUBLIC MEETING OSINO RESOURCES' TWIN HILLS GOLD PROJECT, KARIBIB DISTRICT, ERONGO REGION, NAMIBIA**

Environmental Compliance Consultancy Co. hereby gives notice to all members of the public that an application for an Environmental Clearance Certificate in accordance with the Environmental Management Act, No. 7 of 2007 will be made for gold mining in the Erongo Region. Members of the public are invited to register as an Interested and Affected Party (IAP), attend the first round of public meetings and provide input into the environmental and social impact assessment.

**Applicant:** Osino Gold Exploration and Mining (Pty) Ltd, Environmental Compliance Consultancy Erongo Region, Namibia

**Location:** Twin Hills Gold Project near Karibib, Erongo Region, 12 km northeast of Karibib, opposite the Karibib Air Base

**Project Title:** Twin Hills Gold Project

**Project Location:** 12 km northeast of Karibib, opposite the Karibib Air Base

**Activity:** The proposed project will entail open pit mining by conventional drill & blast, load & haul with a fleet of mobile mining equipment. Gold bearing ore will be processed by crushing, cyanide leaching, carbon-in-pulp (CIP) processing, electro-winning and then smelting in an induction furnace to produce gold bars.

**Public Meetings:** Windhoek, Tuesday, 31st August 2021  
1. First Meeting: 15:30 at the Scientific Society  
2. Second Meeting: 19:30 at the Scientific Society

**Omanuru, Wednesday, 1st September 2021**  
3. First Meeting: 15:30 at the Central Hotel  
4. Second Meeting: 19:30 at the Central Hotel

**Karibib, Thursday, 2nd September 2021**  
5. Third Meeting: 15:30 at Karibib Town Hall  
6. Fourth Meeting: 19:30 at Karibib Town Hall

**Register & Attend:**  
1. Please register as an IAP  
2. Register for the project at: <https://eccenvironmental.com/projects/> or call ECC to register  
3. Registered IAPs will receive a project Background Information Document (BID).

The closing date to receive written comments and / or concerns will be the 24th September 2021.

In addition to the above meetings, Osino Gold Exploration and Mining (Pty) Ltd are committed to engaging all affected stakeholders through planned, ongoing public participation in the form of focus groups and further meetings as required.

Environmental Compliance Consultancy  
Registration Number: DC2013/11464  
Members: Mr JB Bezuidenhout & Mrs J Mooney  
PO Box 11153, Klein Windhoek  
Tel: +264 81 689 7500  
E-mail: [info@eccenvironmental.com](mailto:info@eccenvironmental.com)  
Website: <http://www.eccenvironmental.com>  
Project ID: ECC-103-320-ADT-10-A





**Notices**

**Legal**

**INVESTMENT (PTY) LTD 1st Defendant NICOLUS MUAUTUJI MUAUTUJI 2nd Defendant NOTICE OF SALE IN EXECUTION** In execution of a judgment of the above Honourable Court dated 19 MARCH 2021 in the above action, a sale without reserve will be held by the Deputy Sheriff, WINDHOEK, at ERIF 166 NO 36 TOERMAVYN STREET, EROSPARK, WINDHOEK, on 9 SEPTEMBER 2021, at 12:00, of the under mentioned property: CERTAIN: Erf No. 166 EROSPARK SUBSITE in the Municipality of Windhoek (Registration Division "C") Khomas Region. MEASUREMENT: 1407 (One Thousand Four Hundred and Seven) square metres Improvements: 1 x Kitchen, 1 x Lounge, 1 x dining, 5 x bedrooms, 1 x Full bathroom, 2 x SH/wc/hwt, 1 x bath/sh/wc/hwt, 1 x wc/hwt, 1 x Garage, 1 x BBQ, 1 x swimming pool

**Bachelor's Flat:** 1 x bedroom, 1 x SH/wc/hwt

**TERMS** 10% of the purchase price and the auctioneer's commission must be paid on the date of the sale. The further terms and conditions of the sale will be read prior to the auction and lie for inspection at the office of the Deputy Sheriff, WINDHOEK and at the offices of the execution creditor's attorneys, AUCTIONEER'S NOTE: REFUNDABLE REGISTRATION FEE OF N\$5 000,00. DATED at WINDHOEK this 26th day of JULY 2021. DR WEDER KAUTA & HOEVA INC. Legal Practitioner for Plaintiff 3RD Floor WKH House Jan Jonker Road WINDHOEK [P/K/Reg/M483322]

**Notices**

**Public**

**Bellang Mining Services** hereby wish to inform all relevant parties that blasting will be conducted on the new road from Windhoek to the airport on the 27 August 2021. Bellang Mining will start preparations for the blast at 09:00 and the initial blasting will commence between 15:30 and 16:30, during this hour we will close off all the roads that are leading to the blasting site with blast guards and red flags. We will also drive around with an audible siren at nearby villages and houses within 1km of the blasting site. The exact location of the blast for 27 August 2021 will be at KM 8 + 700 For further enquiries please call the blaster SALMON VRIES 0812226589

# Cosafa Women's Champions League kicks off

**• HELGE SCHÜTZ**

THE 2021 TotalEnergies Confederation of African Football (CAF) Women's Champions League Cosafa Qualifiers will get underway in Durban, South Africa, tomorrow.

Seven teams will battle it out for a place at the continental CAF Women's Champions League.

Tura Magic will represent Namibia in the tournament that will also see some southern African heavyweights in action, like South African champions Mamelodi Sundowns, Green Buffaloes of Zambia, and Zimbabwean champions Black Rhino Queens.

Tura Magic will compete in Group B, with their opening match against Black Rhino Queens only on Sunday, but the action gets underway tomorrow with two Group A matches at the King Zwelithini Stadium in Durban.

Double Action Ladies of Botswana take on Manzini Wanderers of Eswatini at 11h00, while Mamelodi Sundowns take on Lesotho Defence Force at 14h00.

Sundowns will be strong favourites to win the group and progress to the semi-finals, where the winner of Group A will take on the runner-up of Group B, and vice versa.

Sundowns have been in fine form in the South African Hollywoodbets Women's Super League, and currently hold a six-point lead at the top of the log. They are still unbeaten

after 12 matches, having won 11 and drawn one, while they racked up some emphatic wins over the past month.

On 7 August they thrashed Tsunami Queens 8-0, a week later they beat Richmond United 5-1, and on 21 August they beat Malindi Ladies 3-0 to lead the log on 34 points from 12 matches, followed by University of Cape Town on 28, and Tshwane University of Technology on 27.

Sundowns have been boosted by seasoned Banyanastriker Rhoda Mulaudzi, who recently returned from Russian club Dynamo Minsk, while experienced midfielder Lerato Kgasago has returned from injury.

Sundowns coach Jerry Tshabalala was certainly confident of their chances of winning the tournament.

"What we just need to do is go out there and win our group. By winning our group, it will give us a fair chance to be able to put one foot into Cairo," he was quoted as saying by cosafa.com, adding they hoped to emulate their men's team that won the CAF Champions League in 2016.

Group B will get underway on Friday, with Green Buffaloes of Zambia taking on Zimbabwe's Black Rhino Queens.

Green Buffaloes are probably the favourites in Group B, and have a star-studded side that includes several players who represented Zambia at the recent 2020 Tokyo Olympic Games.

Defenders Lushumo



Photo: Helge Schütz

**EXPERIENCED ...** Thomalina Adams (centre) in action for Tura Magic.

Mweemba, Martha Tembo and Anita Mulunga, and midfielders Ireen Lungu and Agness Musase were all part of the Zambian team that finished third in Group F at the Olympics, after drawing 4-4 against China, and losing 10-3 to the Netherlands and 1-0 to Brazil.

Zambia's star player at the Olympics, Barbra Banda, who scored hat-tricks against the Netherlands and China, and plays for the Chinese club Shanghai Shengli, recently boosted the Buffaloes when she visited them at a training session to wish them well.

"Superstar and 2020

Olympics record-breaker Barbra Banda visited Green Buffaloes during a training session and encouraged the girls to work hard and to put in more effort to achieve their goals," the club said in a statement. The Buffaloes' assistant coach Carol Kanyamba is also confident of success.

"We are definitely going to Cairo. We want to be the first ones to represent Zambia at the CAF Women's Champions League," she says. Black Rhino Queens have not been in competitive action for two years due to the Covid-19 pandemic, but coach Malven Moyo says

they are confident they will do well.

"We last played in 2019, but we have been training in batches here and there. This year we have not trained due to the restrictions, but we have given our players individual training, and our fitness trainer and coaches have been monitoring the players and visiting them individually," he says.

Tura Magic meanwhile announced that Timo Tjongarero will take over as head coach for the tournament, with his regular coach, Shama Gure, acting as his assistant.

The experienced Tjongarero led the Namibian men's team to the 2016 Cosafa u17 title. "We've been at the Cosafa Cup before and the experience is there, so for me it's just to work closely with the guys who have been with the team in the past few months to guide me and familiarise myself with the current players."

"I believe all the players want this; they want to win. That's the take-off point, despite having limited time to prepare. But we will ensure that we are well prepared and that we put up a great performance at the tournament," he says.

# Titans to provide stern challenge

**• HELGE SCHÜTZ**

**HOT** on the heels of the Emerging Zimbabwean team's tour to Namibia, the Momentum Multiply Titans arrive this week for a cricket series against the Namibian Eagles.

The Eagles were emphatic victors against Emerging Zimbabwe after winning all their six matches, but the Titans are bound to provide a sterner test.

They include some South African Test players like Dean Elgar, Theunis de Bruyn, Junior Dala and Aaron Phangiso, as well as some up-and-coming national junior players like Corbin Bosch, Dayaan Galiem, Jan Hendrik Pretorius and Neil Brand.

The two sides will compete in a five-match tournament, consisting of four T20s and one 50-over game, at the Wanderers cricket ground.

"Hosting the Momentum Multiply Titans is the highlight on our calendar.

We missed the series in 2020 due to the Covid-19 pandemic and we are eager to host them this

year. This series falls into a conjunction with our first ever APS Pink Day.

This day is part of our #Pledge4Pink campaign in support of cancer awareness which includes various events and fundraising initiatives," Cricket Namibia said in a press release yesterday.

Cricket Namibia CEO Johan Muller said he is looking forward to a tough on-field contest which is all part of our build-up towards the T20 World Cup later this year.

"They are one of the most successful franchise teams from South Africa and it will be a good contest for our team to measure for ourselves. A unique relationship has developed between the two entities.

We also hope the fixture becomes a permanent event on our calendars."

The tour gets underway with the 50-over match on Saturday, 28 August, while the T20 series starts the next day.

There will be three more T20 matches on 31 August and 1 and 2 September.

Namibia national men's



Photo: Helge Schütz

**MASTER BLASTER ...** JJ Smit in action for Namibia.

squad: Gerhard Erasmus (captain), Mauritius Ngupita, JJ Smit, Jan Frylineck, Karl Birkenstock, Ben Shikongo, Bernard Scholtz, Nicol Lottie-Eaton, Craig Williams, Michael van Lingen, Stephen Beard, Ruben Trunpelmann, Zane Green, Shaun Fouche, Picky Ya France.

Momentum Multiply Titans squad: Dean Elgar, Corbin Bosch, Junior Dala, Dayaan Galiem, Aya Gqamane, Okuhle Cele, Neil Brand, Jiveshen Pililay, Theunis de Bruyn, Grant Mokoena, Aaron Phangiso, Gilahln Cloete, Sibonelo Makhanya, Jan-Hendrik Pretorius.

**NOTICE OF AN ENVIRONMENTAL ASSESSMENT AND PUBLIC MEETING**  
**OSINO RESOURCES' TWIN HILLS GOLD MINE PROJECT,**  
**KARIBIB DISTRICT, ERONGO REGION, NAMIBIA**

Environmental Compliance Consultancy Cc. hereby gives notice to all members of the public that an application for an Environmental Clearance Certificate in accordance with the Environmental Management Act, No. 7 of 2007 will be made for gold mining in the Erongo Region. Members of the public are invited to register as an Interested and Affected Party (IAP), attend the first round of public meetings and provide input into the environmental and social impact assessment.

**Applicant:** Osino Gold Exploration and Mining (Pty) Ltd.  
**Environmental Assessment Practitioner (EAP):** Environmental Compliance Consultancy  
**Location:** Erongo Region, Namibia

**Project Title:** Twin Hills Gold Project near Karibib, Erongo Region.  
**Project Location:** 12 km northeast of Karibib, opposite the Karibib Air Base

**Activity:** The proposed project will entail open pit mining by conventional drill & blast, load & haul with a fleet of mobile mining equipment. Gold-bearing ore will be processed by crushing, cyanide leaching, carbon-in-pulp (CIP) processing, electro-winning and then smelting in an induction furnace to produce gold bars.

**Public Meetings:**  
**Windhoek, Tuesday, 31st August 2021** Address: 110 Robert Mugabe Avenue, Windhoek  
1. First Meeting: 14:30 at the **Scientific Society**  
2. Second Meeting: 18:30 at the **Scientific Society**

**Omaruru, Wednesday, 1st September 2021** Address: Wilhelm Zeraus Rd, Omaruru  
3. First Meeting: 14:30 at the **Central Hotel**  
4. Second Meeting: 18:30 at the **Central Hotel**

**Karibib, Thursday, 2nd September 2021** Address: 19 Kalk Street, Karibib  
5. First Meeting: 14:30 at **Karibib Town Hall**  
6. Second Meeting: 18:30 at **Karibib Town Hall**

**Register & Attend:**  
1. Please register as an IAP  
2. Register for the project at: <https://eccanv.com/namibia/103320ADT104> or call ECC to register  
3. Registered IAPs will receive a project Background Information Document (BID).

**The closing date to receive written comments and / or concerns will be the 24th September 2021.**

In addition to the above meetings, Osino Gold Exploration and Mining (Pty) Ltd are committed to engaging all affected stakeholders through planned, ongoing public participation in the form of focus groups and further meetings as required.

**Environmental Compliance Consultancy**  
**Registration Number:** CC201311404  
**Members:** Mr JS Bezuidenhout or Mrs J Mooney  
PO Box 91193, Klein Windhoek  
Tel: +264 81 669 7608  
**Email:** info@eccenvironmental.com  
**Website:** <http://www.eccenvironmental.com>  
**Project ID:** ECC-103-320-ADT-104

The Market Watch: The Namibian Sun, Republikein and the Allgemeine Zeitung newspapers, 18th and 25th of August 2021

WEDNESDAY 18 AUGUST 2021

Market Watch

Republikein Sun Allgemeine Zeitung 9

**OSINO**  
RESOURCES

**NOTICE OF AN ENVIRONMENTAL ASSESSMENT AND PUBLIC MEETING**  
OSINO RESOURCES' TWIN HILLS GOLD PROJECT, KARIBIB DISTRICT,  
ERONGO REGION, NAMIBIA

Environmental Compliance Consultancy (ECC) hereby gives notice to all members of the public that an application for an Environmental Clearance Certificate in accordance with the Environmental Management Act, No. 100 of 2007 will be made for gold mining in the Erongo Region. Members of the public are invited to register as an interested and affected party (IAP) attend the first round of public meetings and provide input into the environmental and social impact assessment.

**Applicant:** Osino Gold Exploration and Mining (Pty) Ltd.  
**Environmental Assessment Practitioner (EAP):** Environmental Compliance Consultancy  
**Location:** Erongo Region, Namibia

**Project Title:** Twin Hills Gold Project near Karibib, Erongo Region.  
**Project Location:** 12km northeast of Karibib, opposite the Karibib Air Base

**Activity:** The proposed project will entail open pit mining by conventional drift & blast, load & haul with a fleet of mobile mining equipment. Gold bearing ore will be processed by crushing, cyclone washing, carbon in pulp (CIP) processing, electro-winning and then smelting in an induction furnace to produce gold bars.

**Public Meetings**

**Windhoek, Tuesday, 31st August 2021**

1. First Meeting: 14:30 at the Scientific Society  
2. Second Meeting: 18:00 at the Scientific Society

**Onarua, Wednesday, 1st September 2021**

1. First Meeting: 14:30 at the Central Hotel  
2. Second Meeting: 18:30 at the Central Hotel

**Karibib, Thursday, 2nd September 2021**

1. Third Meeting: 14:30 at Karibib Town Hall  
2. Fourth Meeting: 18:30 at Karibib Town Hall

**Register & Attend:**

- Please register as an IAP
- Register for the project at: <http://www.environmental.com.na/apply> or call ECC to register
- Registered IAPs will receive a project Background Information Document (BID).

The closing date to receive written comments and/or concerns will be the 24th September 2021.

In addition to the above meetings, Osino Gold Exploration and Mining (Pty) Ltd are committed to engaging all affected stakeholders through planned, ongoing public participation in the form of focus groups and further meetings as required.

Environmental Compliance Consultancy  
Registration Number: CC/2020/1469  
Members: Mr B Brandhorst and Mr J Honey  
PO Box 91193, Otjomuho, Windhoek  
Tel: +264 61 289 7000  
E-mail: [info@ecc.com.na](mailto:info@ecc.com.na)  
Website: [www.environmental.com.na](http://www.environmental.com.na)  
Project ID: ECC-103-320-REP-01-A



**ENVIRONMENTAL IMPACT ASSESSMENT**  
**FOR MINING OF BLUE SODALITE DIMENSION**  
**STONE, NEAR OTJIMUHAKA, WITHIN MINING**  
**CLAIM (MC) 70783 AND 70784 EPUPA**  
**CONSTITUENCY, KUNENE REGION**

Notice is hereby given in terms of the Environmental Management Act, No.7 of 2007 and the Environmental Impact Assessment (EIA) Regulations (Government Notice No. 30 of 2012) that an application will be made to the Environmental Commissioner for an environmental clearance of the planned mining activities on Mining Claims 70783 & 70784.

Description of proposed activities: Mining of semi - precious stone and dimension stone within Mining Claims 70783 and 70784.

Location of the MC area: Approximately 80 km northwest from Opuwo and about 3 km south-west of the Namibian-Angolan border, marked by the Kunene River, and 10 km south-west of the settlement Otjimuhaka (previously Swartbooisdrif), Kunene Region as shown on the map below:

Interested and Affected Parties (I&AP) are requested to register to obtain a Background Information Document. Persons having any comments to the proposed activities may lodge such comments, duly motivated in writing to the address provided below by the 10th September 2021. The full Environmental Impact Assessment (EIA) report and the draft Environmental Management Plan (EMP) will be provided to the registered I&AP.



**Contact Details:**  
Postal Address: P. O. Box 61307, Olympia, Windhoek  
Tel: +264 61 289 9716 OR +264 61 435 1689  
E-mail: [oliver@gecko.na](mailto:oliver@gecko.na) OR [luisa.amwela@gecko.na](mailto:luisa.amwela@gecko.na)

**BROADCASTING SCHEDULE WEDNESDAY - 18 AUGUST 2021**

BROADCASTING LIVE • 24/7 • 365 • REPEAT

Powered by:  SCAN THE QR CODE TO WATCH ALL SHOWS

MORNING - AFTERNOON			AFTERNOON - EVENING			EVENING - NIGHT		
Time	Show	Type	Time	Show	Type	Time	Show	Type
7:00	Africa Good Morning	News	15:00	NMH Ad spotter	Entertainment	23:00	Namibian Music	Music
7:30	Africa Good Morning	News	15:30	Flex	Entertainment	23:30	Namibian Music	Music
8:00	Evening Review	Factual	16:00	Active Kids	Children	0:00	Namibian Music	Music
8:30	Africa Good Morning	News	16:30	Careers	Entertainment	0:30	Namibian Music	Music
9:00	Africa Good Morning	News	17:00	Business 7	Entertainment	1:00	NMH@1	News
9:30	Online School 0	Children	17:30	Wind Down	Entertainment	1:30	Careers	Entertainment
10:00	Active Kids	Children	18:00	Wind Down	Entertainment	2:00	lilli	Music
10:30	Online School 1	Children	18:30	Flex	Entertainment	2:30	Business 7	Entertainment
11:00	Online School 2	Children	19:00	Business 7	Entertainment	3:00	Namibia sonder grasse	Entertainment
11:30	Online School 3	Children	19:30	Erongo Talk	Entertainment	3:30	Erongo Talk	Entertainment
12:00	NMH Ad spotter	Entertainment	20:00	Kletskompas	Entertainment	4:00	Kletskompas	Entertainment
12:30	Kletskompas	Entertainment	20:30	We Talk	Entertainment	4:30	We Talk	Entertainment
13:00	NMH@1	News	21:00	Evening Review	Factual	5:00	Evening Review	Factual
13:30	We talk	Entertainment	21:30	Namibia Sonder Grasse	Entertainment	5:30	Africa Good Morning	News
14:00	Erongo Talk	Entertainment	22:00	NMH@1	News	6:00	Africa Good Morning	News
14:30	Evening Review	Factual	22:30	Namibian Music	Music	6:30	flex	Entertainment

To view all our shows, live or repeats, visit [www.oneuptwo.com](http://www.oneuptwo.com) or scan the QR above.



**OSINO**  
RESOURCES

**NOTICE OF AN ENVIRONMENTAL ASSESSMENT AND PUBLIC MEETING**  
**OSINO RESOURCES' TWIN HILLS GOLD PROJECT, KARIBIB DISTRICT, ERONGO REGION, NAMIBIA**

Environmental Compliance Consultancy (ECC) hereby gives notice to all members of the public that an application for an Environmental Clearance Certificate in accordance with the Environmental Management Act, No. 7 of 2007 will be made for gold mining in the Erongo Region. Members of the public are invited to register as an interested and affected party (IAIP), attend the first round of public meetings and provide input into the environmental and social impact assessment.

**Applicant:** Osino Gold Exploration and Mining (Pty) Ltd.  
**Environmental Assessment Practitioner (EAP):** Environmental Compliance Consultancy  
**Location:** Erongo Region, Namibia

**Project Title:** Twin Hills Gold Project near Karibib, Erongo Region  
**Project Location:** 12 km northeast of Karibib, opposite the Karibib Air Base

**Activity:** The proposed project will entail open pit mining by conventional drill & blast, load & haul with a fleet of mobile mining equipment. Gold bearing ore will be processed by crushing, grizzly leaching, carbon-in-pulp (CIP) processing, electro-winning and then smelting in an induction furnace to produce gold bars.

**Public Meetings:**

<b>Windhoek, Tuesday, 21st August 2021</b>	Address: 112 Robert Mugabe Avenue, Windhoek
1. First Meeting: 18:30 at the Scientific Society	
2. Second Meeting: 18:30 at the Scientific Society	
<b>Omaruru, Wednesday, 1st September 2021</b>	Address: Wilhelm Strasse 31, Omaruru
3. First Meeting: 18:30 at the Central Hotel	
4. Second Meeting: 18:30 at the Central Hotel	
<b>Karibib, Thursday, 2nd September 2021</b>	Address: 19 Eak Street, Karibib
5. Third Meeting: 18:30 at Karibib Town Hall	
6. Fourth Meeting: 18:30 at Karibib Town Hall	

**Register & Attend:**

- Please register as an IAIP
- Register for the project at: <https://osinoenvironmental.com/iaipact/> or call ECC to register
- Registeres (IAIP) will receive a project background information document (PID).

The closing date to receive written comments and / or concerns will be the 24<sup>th</sup> September 2021.

In addition to the above meetings, Osino Gold Exploration and Mining (Pty) Ltd are committed to engaging all affected stakeholders through planned, ongoing public participation in the form of focus groups and further meetings as requested.

Environmental Compliance Consultancy  
Registration Number: CC72913/21404  
Members: Mr & Ms Siedelweber & Mrs. H. Hooyse  
PO Box 52201, Gera Windhoek  
Tel: +264 81 622 7446  
Email: [info@osinoenvironmental.com](mailto:info@osinoenvironmental.com)  
Website: <http://www.osinoenvironmental.com>  
Project No: ECC-103-320-ND-36-A



**A BRIGHTER OPPORTUNITY FOR YOUR TOMORROW**

# TENDERS

**TENDER ENQUIRY NO. EL16-ND-2021**

**INVITATION TO TENDER FOR THE PROVISION OF DRILLING & BLASTING SERVICES**

Namdeb Diamond Corporation (Pty) Ltd hereby invites reputable and qualified service providers to submit tenders for **The Provision of Drilling and Blasting Services**.

**1. SCOPE OF WORKS SUMMARY:**

- 1.1. The provision of drilling and blasting services at Southern Coastal Mines; and
- 1.2. The provision of drilling services and the rental and operation of a mobile-injuring unit for blasting at Orange River Mines.

**2. IMPORTANT COMMERCIAL REQUIREMENTS:**

- 2.1. Code of Conduct Certificates: Directors/Members; and
- 2.2. Good Standing Certificates:
  - a) Ministry of Finance;
  - b) Social Security Commission (ECC & MSD); and
  - c) Employment Equity Commission.

**3. TENDER DOCUMENTS**  
Interested parties may contact Elmaranacha Bertoini, at the below listed details to obtain a copy of the tender enquiry document:

Email: [elmaranacha.bertoini@namdeb.com](mailto:elmaranacha.bertoini@namdeb.com)  
Tel: +264 (63) 238 502

**4. COMPULSORY PHYSICAL SITE INSPECTION**  
A compulsory Physical Site Inspection (PSI) shall be conducted on **Wednesday, 15 September 2021, at 10h00**.

Restricted Area Permits (RAP) and Code of Conduct Clearance Certificates are **mandatory** for all Tenderer Representatives attending this event. Due for submission before 10 September 2021, to email address: [elmaranacha.bertoini@namdeb.com](mailto:elmaranacha.bertoini@namdeb.com)

**Only Tenderers who attended the Physical Site Inspection shall be eligible to participate in the tender process.**

**5. CLOSING DATE**  
The closing date for this tender is Friday **24<sup>th</sup> September 2021, at 16h00**.

[www.namdeb.com](http://www.namdeb.com)



**BROADCASTING SCHEDULE WEDNESDAY - 25 AUGUST 2021**

BROADCASTING LIVE • 24/7 • 365 // **REPEAT**

Powered by:  **SCAN THE QR CODE TO WATCH ALL SHOWS**

MORNING - AFTERNOON			AFTERNOON - EVENING			EVENING - NIGHT		
Time	Show	Type	Time	Show	Type	Time	Show	Type
7:00	Africa Good Morning	News	15:00	NMH Ad spotter	Entertainment	23:00	Namibian Music	Music
7:30	Africa Good Morning	News	15:30	Flex	Entertainment	23:30	Namibian Music	Music
8:00	Evening Review	Factual	16:00	Active Kids	Children	0:00	Namibian Music	Music
8:30	Africa Good Morning	News	16:30	Careers	Entertainment	0:30	Namibian Music	Music
9:00	Africa Good Morning	News	17:00	Business 7	Entertainment	1:00	NMH@1	News
9:30	Online School 0	Children	17:30	Wind Down	Entertainment	1:30	Careers	Entertainment
10:00	Active Kids	Children	18:00	Wind Down	Entertainment	2:00	Tjill	Music
10:30	Online School 1	Children	18:30	Flex	Entertainment	2:30	Business 7	Entertainment
11:00	Online School 2	Children	19:00	Business 7	Entertainment	3:00	Namibia sonder grense	Entertainment
11:30	Online School 3	Children	19:30	Erongo Talk	Entertainment	3:30	Erongo Talk	Entertainment
12:00	NMH Ad spotter	Entertainment	20:00	Kietskompas	Entertainment	4:00	Kietskompas	Entertainment
12:30	Kietskompas	Entertainment	20:30	We Talk	Entertainment	4:30	We Talk	Entertainment
13:00	NMH@1	News	21:00	Evening Review	Factual	5:00	Evening Review	Factual
13:30	We Talk	Entertainment	21:30	Namibia Sonder Grense	Entertainment	5:30	Africa Good Morning	News
14:00	Erongo Talk	Entertainment	22:00	NMH@1	News	6:00	Africa Good Morning	News
14:30	Evening Review	Factual	22:30	Namibian Music	Music	6:30	Flex	Entertainment

**To view all our shows, live or repeats, visit [www.oneuptwo.com](http://www.oneuptwo.com) or scan the QR above.**

**- SITE NOTICE**

# OSINO

## RESOURCES

### NOTICE OF AN ENVIRONMENTAL ASSESSMENT AND PUBLIC CONSULTATION

### OSINO RESOURCES' TWIN HILLS GOLD MINE PROJECT, KARIBIB DISTRICT, ERONGO REGION, NAMIBIA

---

Environmental Compliance Consultancy cc (ECC) hereby gives notice to the public that an application for an environmental clearance certificate in accordance with the Environmental Management Act, No. 7 of 2007 will be made as per the following:

**Applicant:** Osino Gold Exploration and Mining (Pty) Ltd.  
**Environmental Assessment Practitioner (EAP):** Environmental Compliance Consultancy  
**Location:** Erongo Region, Namibia

**Project Title:** Osino Resources' Twin Hills Gold Mine project, Karibib, Erongo Region  
**Project Location:** 12 km northeast of Karibib, opposite the Karibib Air Base

**Proposed Project Activity:** The proposed project will entail open pit mining by conventional drill & blast, load & haul with a fleet of mobile mining equipment. Gold bearing ore will be processed by crushing, cyanide leaching, carbon-in-pulp (CIP) processing, electrowinning and then smelting in an induction furnace to produce gold bars.

**Proposed Project Area:** Karibib District, Erongo Region, Namibia

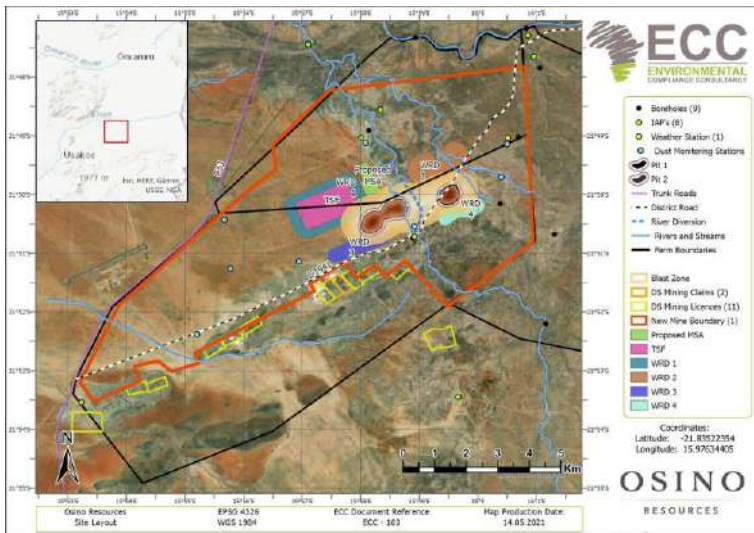

**I&APs Registration:** The purpose of the registration period is to introduce the proposed project and to afford Interested and Affected Parties (I&APs) an opportunity to register and comment on the Background Information Document (BID), to ensure that potential issues and concerns are brought forward, so that they can be considered and assessed during the impact assessment process.

I&APs and stakeholders are required to register for the project at: [www.eccenvironmental.com/projects](http://www.eccenvironmental.com/projects)

The team at ECC will then maintain contact with all registered I&APs to engage and to keep them informed as the ESIA process develops. ECC will also provide registered I&APs input opportunities and review periods throughout the assessment process.



Contact: Mr JS Bezuidenhout or Mrs J Mooney  
 Environmental Compliance Consultancy  
 Registration Number CC/2013/11404  
 PO Box 91193, Klein Windhoek  
 Tel: +264 81 669 7608  
 E-mail: [info@eccenvironmental.com](mailto:info@eccenvironmental.com)  
 Website: [www.eccenvironmental.com/projects](http://www.eccenvironmental.com/projects)





Environmental Compliance Consultancy website:

[www.eccenvironmental.com](http://www.eccenvironmental.com)

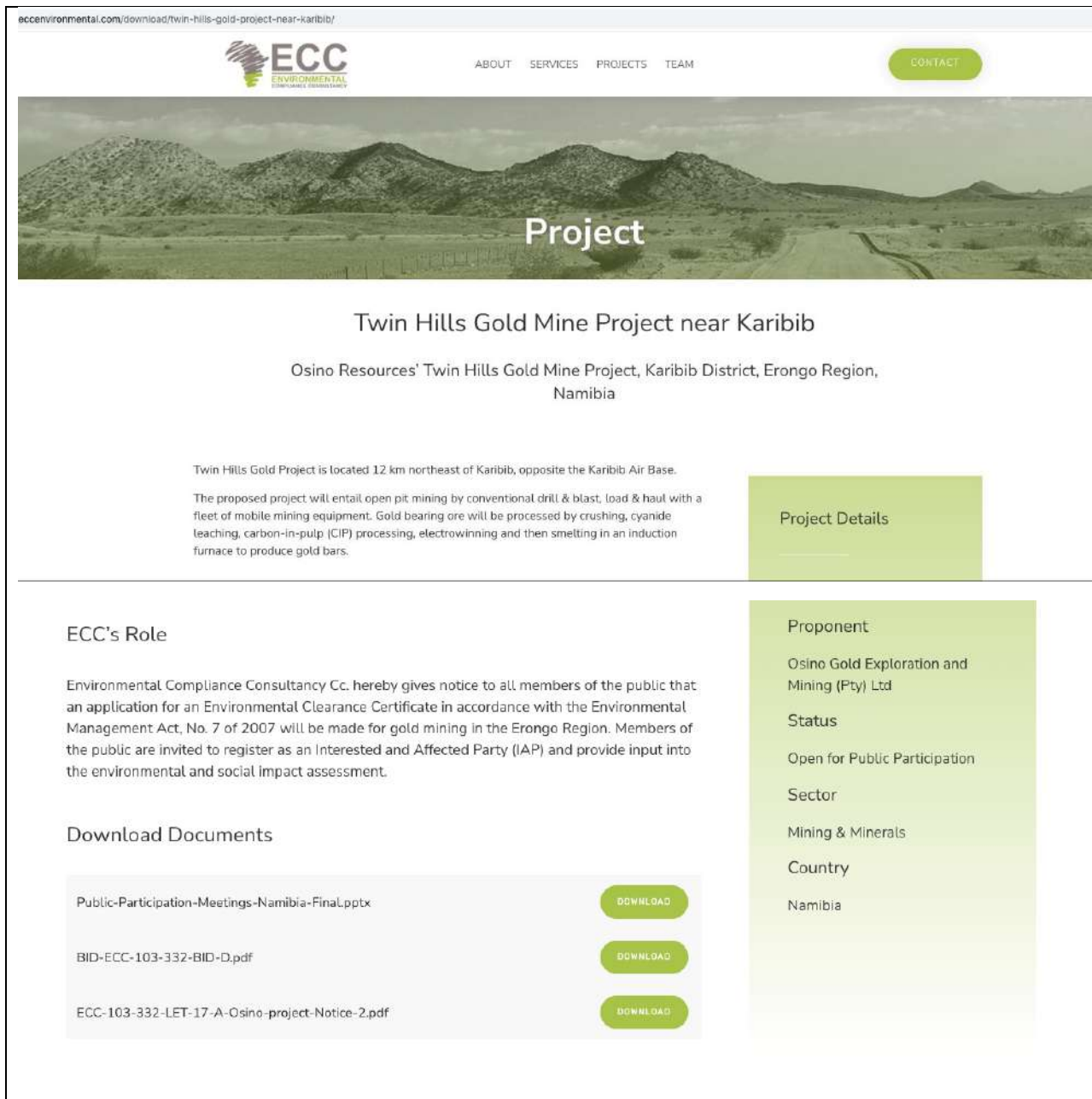

[eccenvironmental.com/download/twin-hills-gold-project-near-karibib/](http://eccenvironmental.com/download/twin-hills-gold-project-near-karibib/)

**ECC**  
ENVIRONMENTAL  
COMPLIANCE CONSULTANCY

ABOUT SERVICES PROJECTS TEAM CONTACT

# Project

## Twin Hills Gold Mine Project near Karibib

Osino Resources' Twin Hills Gold Mine Project, Karibib District, Erongo Region, Namibia

Twin Hills' Gold Project is located 12 km northeast of Karibib, opposite the Karibib Air Base.

The proposed project will entail open pit mining by conventional drill & blast, load & haul with a fleet of mobile mining equipment. Gold bearing ore will be processed by crushing, cyanide leaching, carbon-in-pulp (CIP) processing, electrowinning and then smelting in an induction furnace to produce gold bars.

### Project Details

**Proponent**  
Osino Gold Exploration and Mining (Pty) Ltd

**Status**  
Open for Public Participation

**Sector**  
Mining & Minerals

**Country**  
Namibia

### ECC's Role

Environmental Compliance Consultancy Cc. hereby gives notice to all members of the public that an application for an Environmental Clearance Certificate in accordance with the Environmental Management Act, No. 7 of 2007 will be made for gold mining in the Erongo Region. Members of the public are invited to register as an Interested and Affected Party (IAP) and provide input into the environmental and social impact assessment.

### Download Documents

Public-Participation-Meetings-Namibia-Final.pptx [DOWNLOAD](#)

BID-ECC-103-332-BID-D.pdf [DOWNLOAD](#)

ECC-103-332-LET-17-A-Osino-project-Notice-2.pdf [DOWNLOAD](#)

**- PUBLIC MEETING PRESENTATION**





**ECC**  
ENVIRONMENTAL  
COMPLIANCE CONSULTANCY



# OSINO TWIN HILLS GOLD MINE PROJECT

ESIA PROCESS  
SCOPING PHASE



# Welcome



# AGENDA

- Main Objectives
- Background Information
- Environmental & Social Impact Assessment (ESIA) Process — *Presented by ECC*
- Osino Presentation — *Presented by Heye Daun*
- Potential Biophysical & Socio-economic Impacts - *Presented by ECC*
- Baseline Studies
- Public Participation





## Main Objectives

- ✓ Provide information describing the planned Twin Hills Gold Mine project and associated activities;
- ✓ Provide an independent environmental and social assessment of the activities associated with the proposed mining project; and
- ✓ Develop management and mitigation measures associated with any identified potential impacts where necessary.



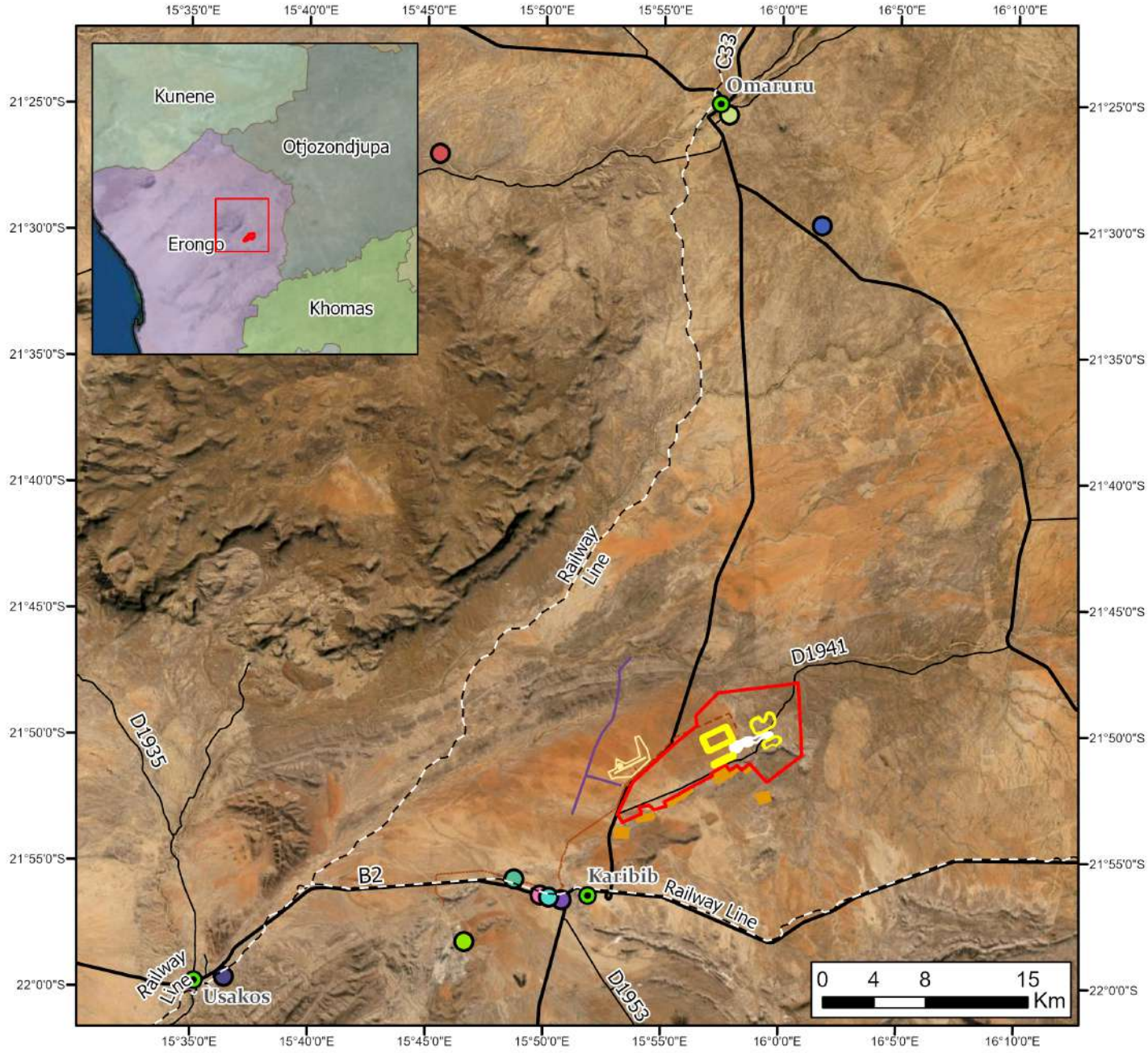

**Infrastructure Map**

- Towns
- Railway
- WRD TSF
- Power Lines
- Mining Pits
- Namwater Pipeline
- Dimension Stone Mining Claims
- Main Roads
- Trunk Roads
- Air Strip
- Mining Licence Boundary

**Substations**

- Gossow Mini Substation 1
- Gossow Mini Substation 2
- Karibib Substation
- Marble Switching Station
- Navachab Substation
- Omaruru Substation
- Omburu Substation
- Otjompauwe Substation
- Usakos Substation

Osino Resources  
Infrastructure Map

ECC Document Reference:  
ECC - 103 - 320

Map Produced:  
July 2021





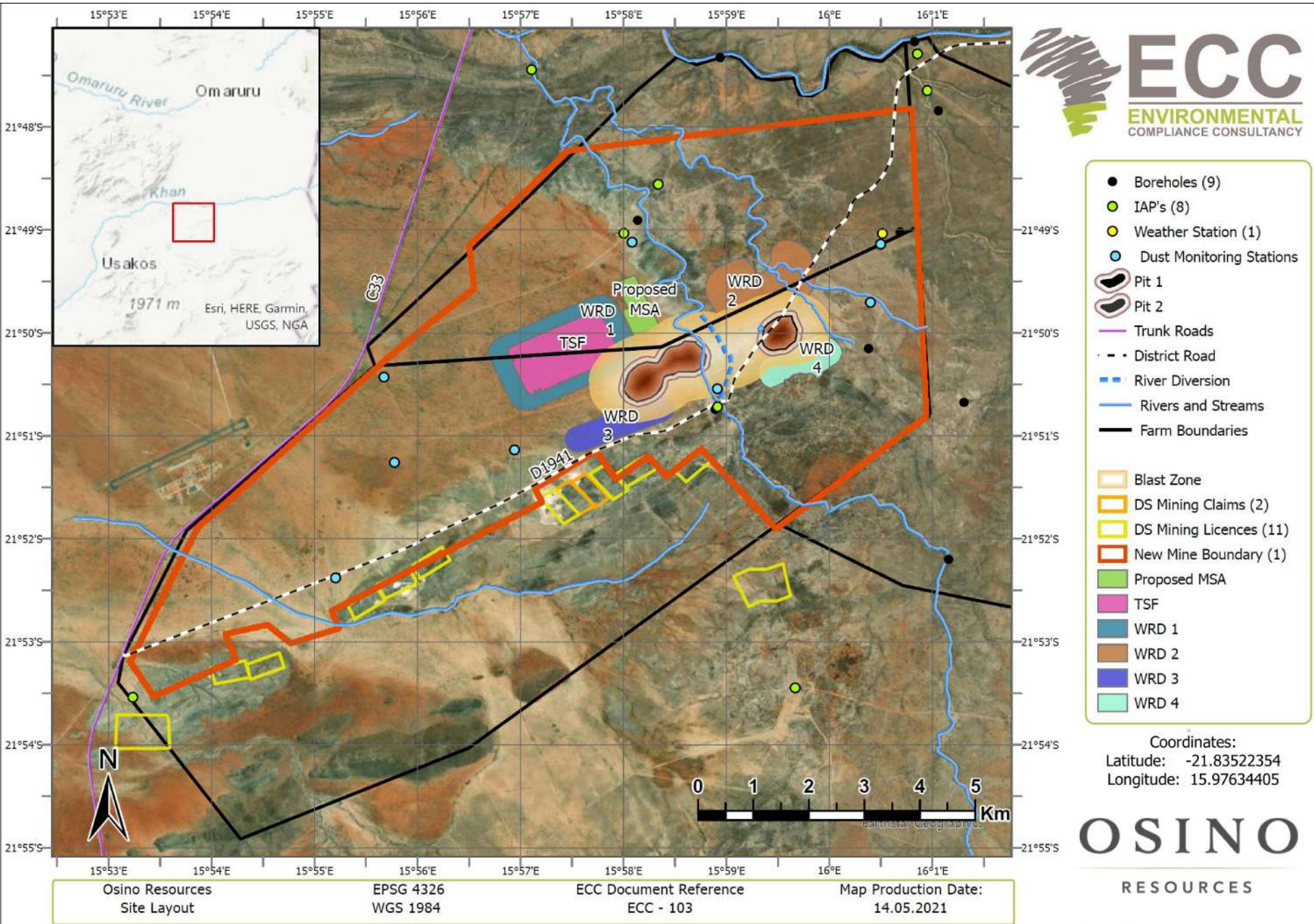





# ESIA Process

- Screening - APP-002920 (DEA PORTAL)
- Scoping – Current Phase
  - Baseline Studies
  - Public Participation
  - Terms of Reference
- Assessment Phase

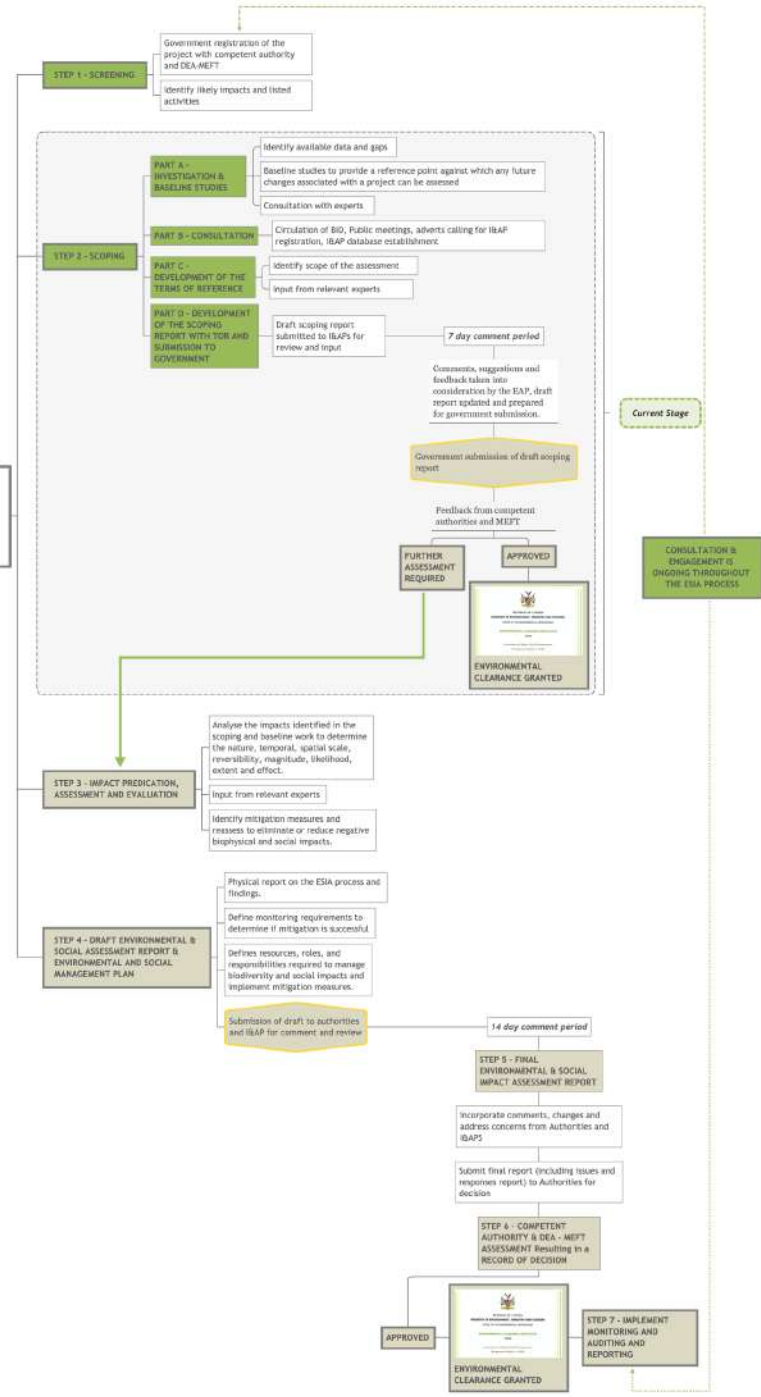



# ESIA Process



- Screening – APP-002920 (DEA PORTAL)

ACTIVITIES THAT TRIGGERED A CLEARANCE CERTIFICATE APPLICATION
ENERGY GENERATION, TRANSMISSION AND STORAGE ACTIVITIES
WASTE MANAGEMENT, TREATMENT, HANDLING AND DISPOSAL ACTIVITIES
MINING AND QUARRYING ACTIVITIES
FORESTRY ACTIVITIES
WATER RESOURCE DEVELOPMENT
HAZARDOUS SUBSTANCE TREATMENT, HANDLING AND STORAGE
INFRASTRUCTURE

**STEP 1 - SCREENING**

- Government registration of the project with competent authority and DEA-MEFT
- Identify likely impacts and listed activities

**STEP 2 - SCOPING**

**PART A - INVESTIGATION & BASELINE STUDIES**

- Identify available data and gaps
- Baseline studies to provide a reference point against which any future changes associated with a project can be assessed
- Consultation with experts

**PART B - CONSULTATION**

Circulation of BID, Public meetings, adverts calling for I&AP registration, I&AP database establishment

**PART C - DEVELOPMENT OF THE TERMS OF REFERENCE**

- Identify scope of the assessment
- Input from relevant experts

**PART D - DEVELOPMENT OF THE SCOPING REPORT WITH TOR AND SUBMISSION TO GOVERNMENT**

Draft scoping report submitted to I&APs for review and input

*7 day comment period*

Comments, suggestions and feedback taken into consideration by the EAP, draft report updated and prepared for government submission.

Government submission of draft scoping report

*Current Stage*

# Public Participation

- Notification of the project – newspapers & site notice boards
- The Background Information Document (BID) provided I&APs with the opportunity to take part in the public participation process.
- Copies have been made available to the interested and affected parties to assist them with providing informed inputs
- This presentation extracts information from the BID to describe the project to those attending the meeting.

# Process

- Screening - APP-002920 (DEA PORTAL)
- Scoping – Current Phase
- **Assessment Phase**
  - Impact prediction and evaluation of alternatives,
  - Assigning mitigation measures
  - Developing monitoring and conceptual rehabilitation plans.
  - This phase culminates in the drafting of the ESIA report and draft Environmental Management Plan (EMP) and
  - Submission to the appropriate competent authorities.

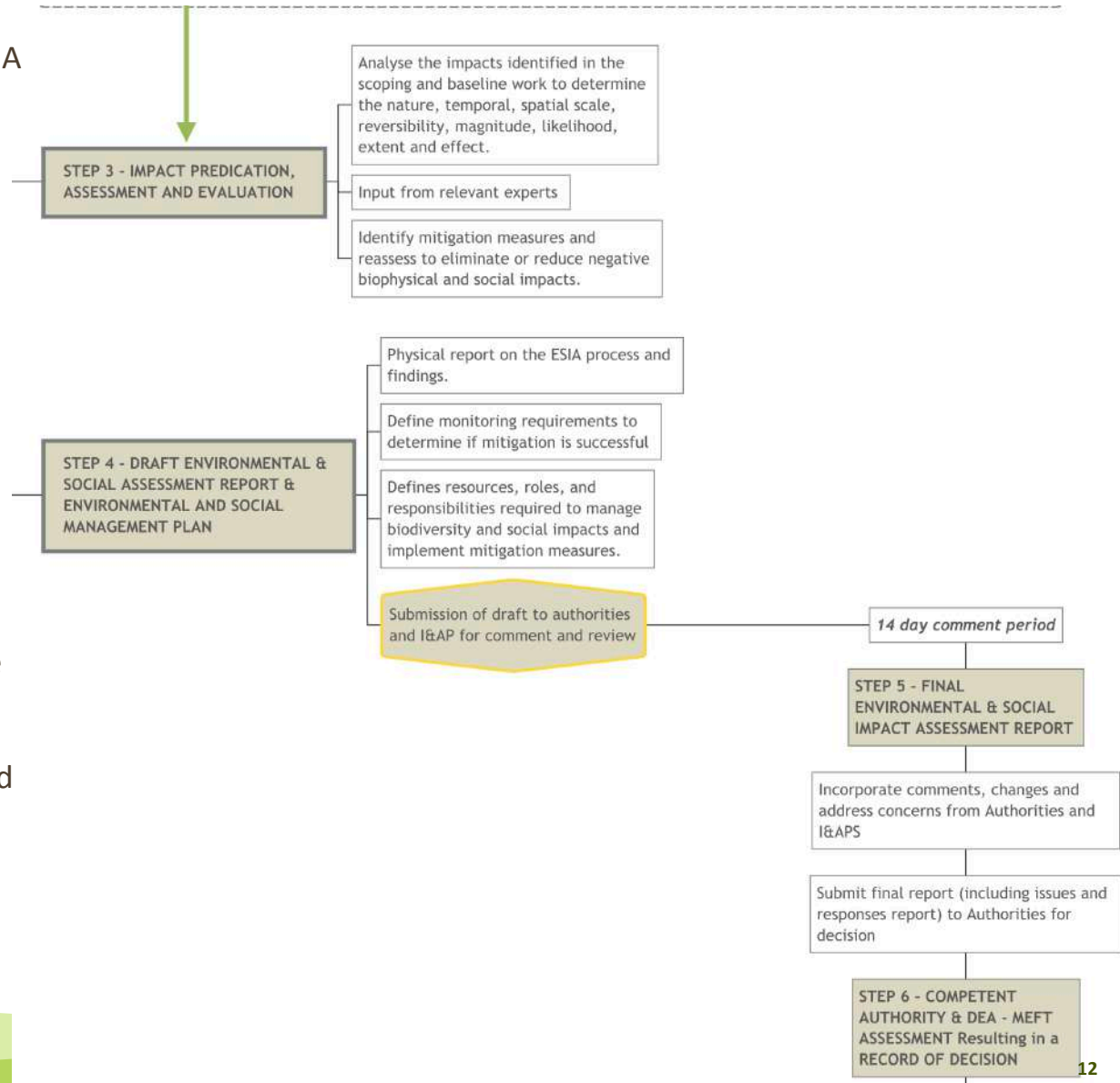



# Baseline Studies Commissioned to date

BASELINE STUDIES	SPECIALIST
A baseline <b>fauna and flora</b> study was completed	Peter Cunningham
A high level or <b>screening water</b> study was completed	SLR
A <b>noise</b> baseline study was completed	AirShed
An <b>air quality</b> baseline study was completed	AirShed
A <b>heritage</b> baseline study was completed	John Kinahan
A high level <b>socio-economic</b> baseline study was completed	Deon Wessels
<b>TO BE COMPLETED</b>	
Traffic surveys have taken place but report is outstanding.	
Visual baseline study	



# Potential Impacts to be assessed

- Potential impacts that can arise from the proposed project include but are not limited to:
  - Dust Pollution
  - Noise impacts
  - Visual impacts
  - Water resource impacts
  - Impact on archaeological and cultural features
  - Biodiversity impacts
  - Increased traffic volumes on public roads
  - Employment opportunities (permanent / temporary)
  - Growth of both local and regional economy
  - Others....







▷ TSXV: OSI  
▷ OTC: OSIIF  
▷ FSE: RSR1

# OSINO

RESOURCES



Namibia Public Participation Meetings  
Growing & Fast-tracking the Twin Hills Gold Project near Karibib

August 2021

**Presenter - Heye Daun: Osino Founder & CEO**

The reader is cautioned that any reference to mineral resources or geological technical information about Osino's mineral properties is based on, excerpted from and expressly qualified by Osino's current technical report (the "Technical Report") which was prepared in accordance with NI 43-101 entitled, "Twin Hills Gold Project, Namibia, NI 43-101 Technical Report" signed May 10, 2021 dated effective April 1, 2021 by Anton Geldenhuys, MEng, MGSSA, PrSciNat #400313/04 of CSA Global South Africa (Pty) Ltd. and Graham Hetherington, BEng, MAusIMM #318140 of Lycopodium Minerals Africa, (Pty) Ltd. prepared for Osino Resources Corp. Accordingly, Osino recommends that the reader refer to and read the Technical Report in its entirety, a copy of which is available on SEDAR at [www.sedar.com](http://www.sedar.com) under Osino's issuer profile.

The results of the Company's preliminary economic assessment ("PEA") that are described herein is a preliminary technical and economic study of the potential viability of the Twin Hills Gold Project. It is preliminary in nature and includes Inferred Mineral Resources that are considered too speculative geologically to have economic considerations applied to them that would enable them to be categorized as Mineral Reserves. In particular, the reader is cautioned that Mineral Resources that are not Mineral Reserves do not have demonstrated economic viability. There can be no assurance, and there is no certainty, that the preliminary economic assessment contained in the PEA results disclosed herein will be realized. Further exploration and evaluation work and appropriate studies are required before Osino will be in a position to estimate any mineralized material reserves or to provide any assurance of an economic development case.

The production target and forecast financial information referred to in this PEA are comprised of both Inferred Mineral Resources and Indicated Mineral Resources. Metallurgical recoveries have been based on test work data and costs have been estimated by independent consultants generally from budget quotations, factored estimates or cost data from similar operations/projects. Cost estimate accuracy for the PEA results described herein are in the order of  $\pm 35\%$ . A more specific description of the assumptions, qualifications, and basis for the results of the PEA are described below, and the key assumptions and economic parameters are set out in Table 2.



**Osino Resources Corp.** is a Canadian gold exploration and project development company, listed on the TSX-V focused on gold exploration in the Namibian Damara orogenic belt generally, and the development of the **Twin Hills gold mining project** specifically.

- **Economically viable** with attractive returns, capital cost and pay-back period
- **Operationally simple** (low technical, geological & metallurgical risk, excellent location)
- **Significant Upside** (additional ounces, mine design & met optimization)
- **Founders Team** with Namibian roots, a proven track record and focused on “doing it right”





## **Heye Daun (President & CEO, Co-Founder):**

Mining engineer and company builder with more than 25 years of mining & public markets experience. Demonstrated ability to deliver value with two successful exits (AYX sold to BTO for C\$180m in 2012 and EGX merged into LUM in C\$200m transaction in 2016). Previous roles in banking & fund management in South Africa. First 10 years of career with Rio Tinto and AngloGold, building & operating mines in Africa.



## **Alan Friedman (Chairman, Co-Founder)**

Toronto-based public markets entrepreneur with more than 20 years of experience & various successful acquisitions, financings & go-public transactions in mining, oil & gas, cannabis, e-sports and technology. Formerly with Investec Bank and Director of the Canada-Southern Africa Chamber of Business.



## **Dave Hodgson (Non-Executive Director):**

Mining industry veteran with decades of experience mainly with Anglo American & De Beers. Former COO & Board member of AngloGold Ashanti. Former Director of Acacia Mining, Uranium One & various other explorers & developers. Former Director of Auryx Gold Corp. during time of sale to B2 Gold Corp.



## **Lazarus Shigwedha (Non-Executive Director):**

Portfolio manager with Investec Asset Management in Cape Town. Broad frontier investment experience across various African sectors and jurisdictions with emphasis on cement, infrastructure and resources. Lazarus is a Namibian citizen and responsible for Investec's significant Namibian pension investments.



## **Margot Naudie (Non-Executive Director):**

Veteran Canadian portfolio manager with 25 years experience managing long-only, long/short, and global natural resource strategies at TDAM, where she served as Managing Director, and CPPIB, where she was Senior Portfolio Manager for the Global Materials sector. She has been voted a Brendan Wood Top Gun in 2009 to 2013. She holds an M.B.A. from the University of Western Ontario, a Bachelor of Arts degree in Political Science/Economics from McGill University, and the Chartered Financial Analyst designation.



## **Marvin Singer (Non-Executive Director):**

Marvin is a former Senior Partner at Norton Rose Fulbright Canada LLP and brings over 40 years of wide-ranging experience in natural resources law to Osino's Board. Norton Rose is one of North America's largest law firms. Since January 2020 he has been a corporate consultant to private and public companies after retiring from practicing corporate, securities and natural resources law.

# Management Team

OSINO

RESOURCES



**HEYE DAUN**  
PRESIDENT & CEO



**TONY DA SILVA**  
CFO



**DAVE UNDERWOOD**  
VP EXPLORATION



**WYNAND SLABBERT**  
EXPLORATION MANAGER



**WERNER SCHUCKMANN**  
COUNTRY MANAGER



**EDWIN DAWETI**  
MINERAL RESOURCE MANAGER



**CHARLES CREASY**  
STUDY MANAGER



**THERESIA MALOBELA**  
SENIOR EXPLORATION GEOLOGIST



**EMMANUEL SHILONGO**  
SENIOR PROJECT GEOLOGIST



**JOLANDA FORTUNATO**  
SENIOR DATABASE GEOLOGIST



**JULIA BECKER**  
INVESTOR RELATIONS MANAGER



**MARIA KAMBAZEMBI**  
OFFICE MANAGER

**Fast-tracked project development**, resource drilling & exploration (+9 drill rigs completed ~51,000m in 2020 and +110,000m planned in 2021). TSX-V compliant **Technical Reports** (MRE/PEA) published in Q1/ Q2 followed by **permitting/feasibility/financing** activities from mid 2021.



PEA Study Manager &  
Coordinating Consultant

Process plant design, met testwork management  
Infrastructure design, capex estimates



**CSA Global**  
Mining Industry Consultants  
an ERM Group company

Geology & Mineral Resource

Domaining & block modelling  
Non-linear geostatistical estimation



**qUBEKA**  
MINING CONSULTANTS

Mine Planning

Pit optimisation, mine scheduling & design  
Cost benchmarking



**ECC**  
ENVIRONMENTAL  
COMPLIANCE CONSULTANCY

Environmental & Social / Closure

Risk Assessment  
Baseline & specialist studies



**kp Knight Piésold**  
CONSULTING

Geohydrology & Surface Water

Water supply studies  
Surface water management



**MAELGWYN**  
MINERAL SERVICES AFRICA

Detailed Metallurgical Testwork

Crushing, milling, mineralogy, heap leach studies  
Diagnostic leach testwork, gravity gold recovery



Geotechnical (Pit & Civil)

Slope angles, civil construction geotech



**OMC**  
orway mineral consultants

Comminution, Hydrometallurgy

Mill sizing



Tailings Management

TSF, WRD & infrastructure location studies



# Ownership & Share Structure

Share Structure		
Shares Basic (m)	110,1	
Shares FDITM (m)	128,4	
ITM Share Options (m)	8,9	38, 30, 80, 120 cps
ITM Warrants (m)	9,4	78, 105cps
Share Price (12m H/L)	\$1.65 / \$0.43	
Cash in treasury (C\$m)	15,8	31 Mar 21
ITM warrants cash (C\$m)	9,6	
<b>Market Cap (C\$m)</b>	<b>133,2</b>	21 Jul 21

Research Coverage	Target (C\$)	Analyst
Cormark	3.20	Richard Gray
M Partners	2.80	Ben Pirie
Sprott	2.75	Brock Salier
IA Financial Group	2.60	George Topping
Beacon Securities	2.50	Bereket Berhe
Stifel GMP	2.30	Alex Terentiew
Echelon Wealth	2.20	Ryan Walker
<b>Consensus Target Price</b>	<b>2.62</b>	

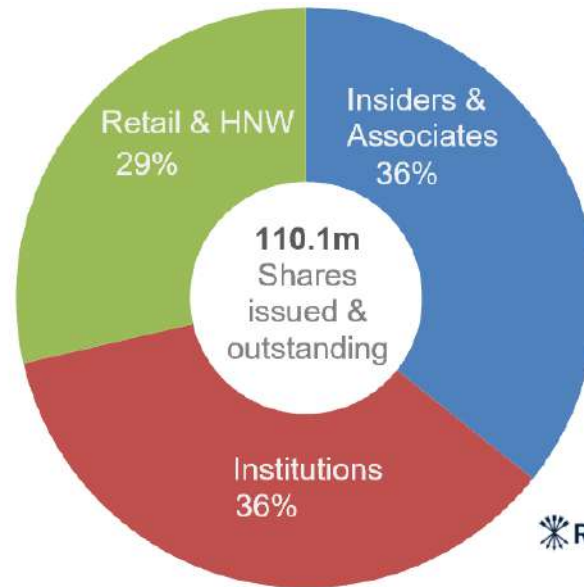

Early-stage Seed Funders:  
Ross Beatty, Co-Founders, RCF



Relative Share Price Performance: 12 Months to 21 July 2021



## Damara Orogenic Belt

- Structurally controlled
- Sediment-hosted Au deposits
- Large tonnage / lower grades often simple metallurgy

## Orogenic Exploration Model

- Source
- Pathway
- Traps

## Neoproterozoic Analogues

- Haile, USA
- Otjikoto, Namibia
- Sukari, Egypt

Excellent regional exploration potential

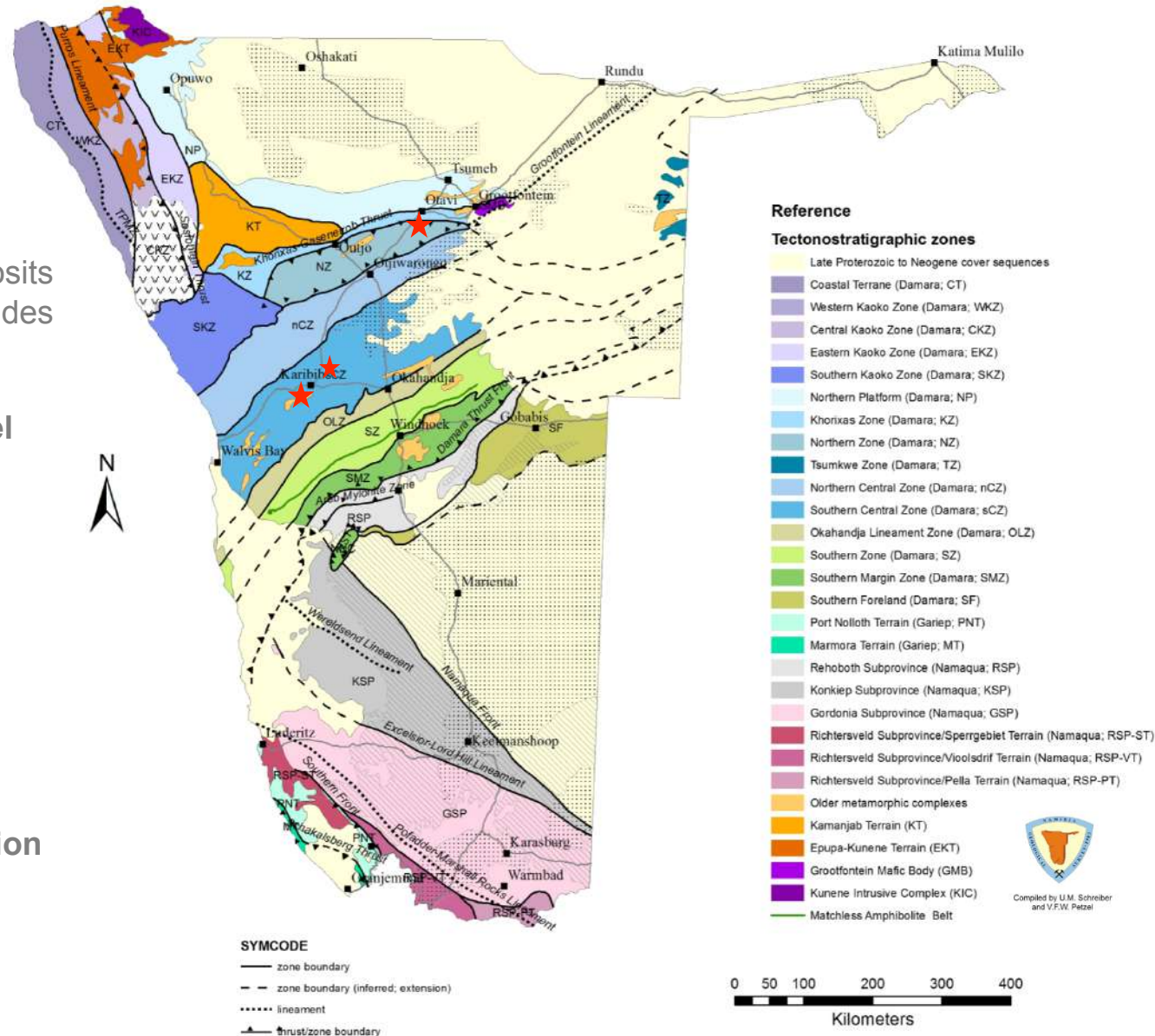

# Osino License Position in Namibia

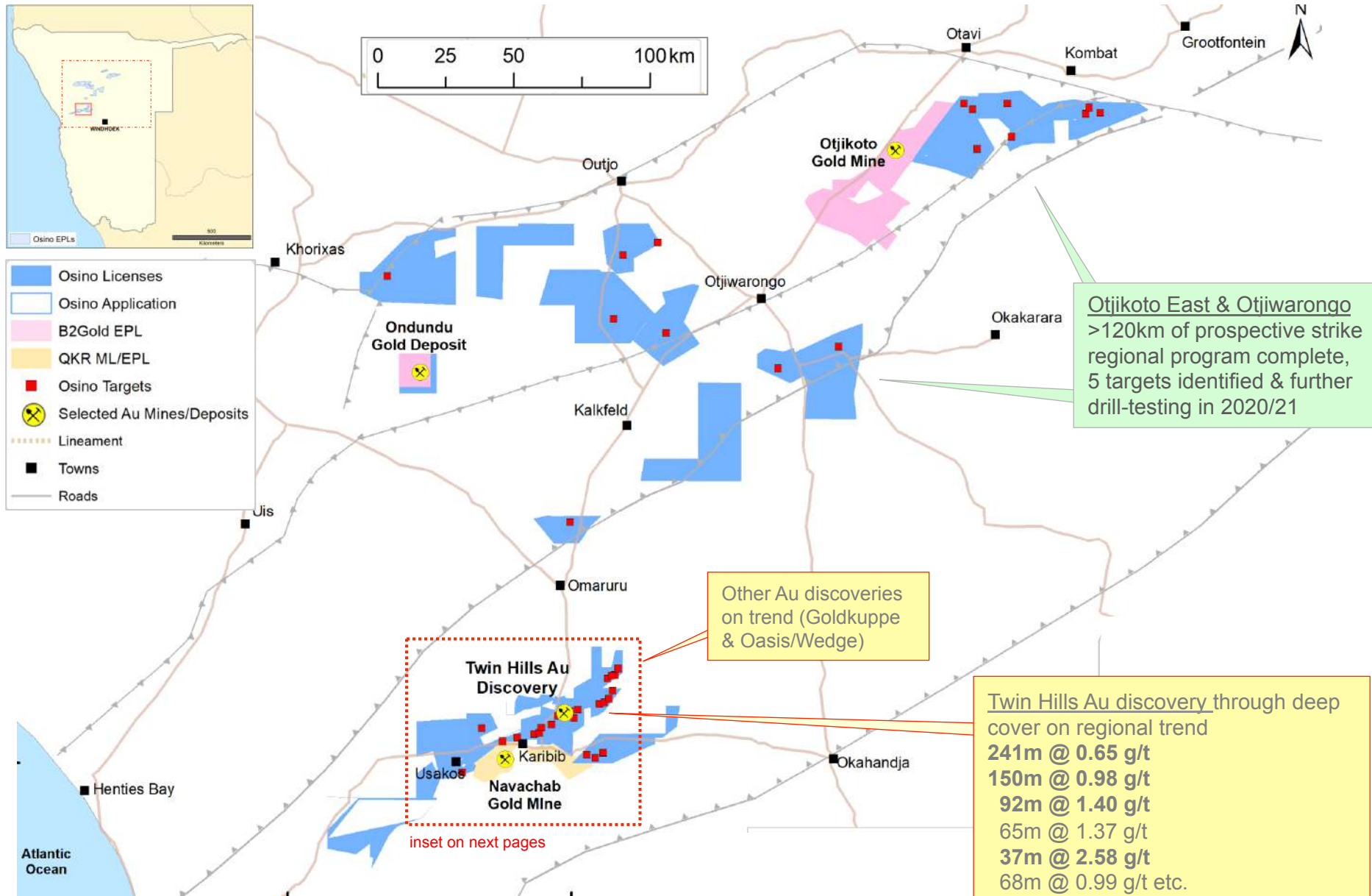



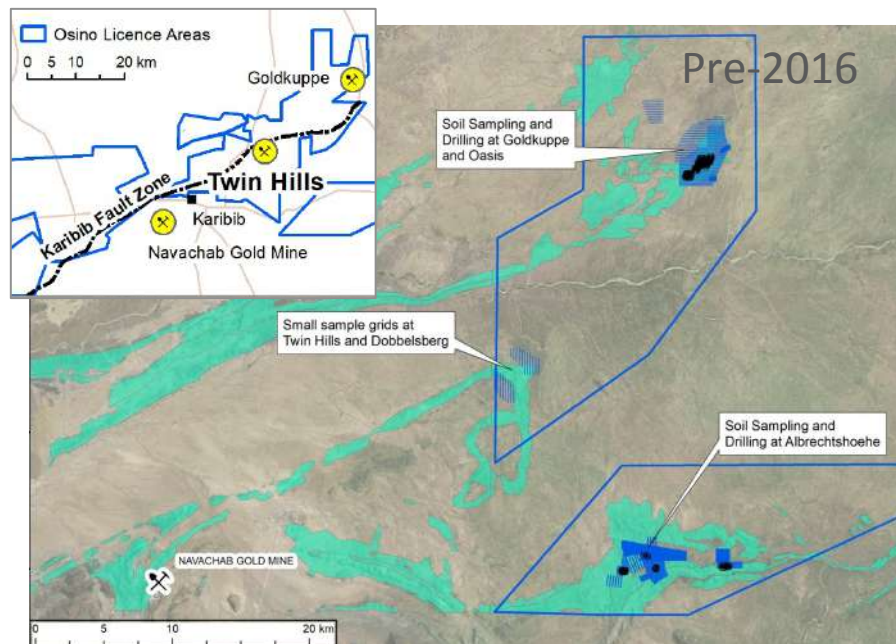

- 2017 – 2020:** Systematic, large-scale exploration using regional geophysics, innovative geochemistry & drilling results in significant, shallow gold discovery from surface within large orogenic system.

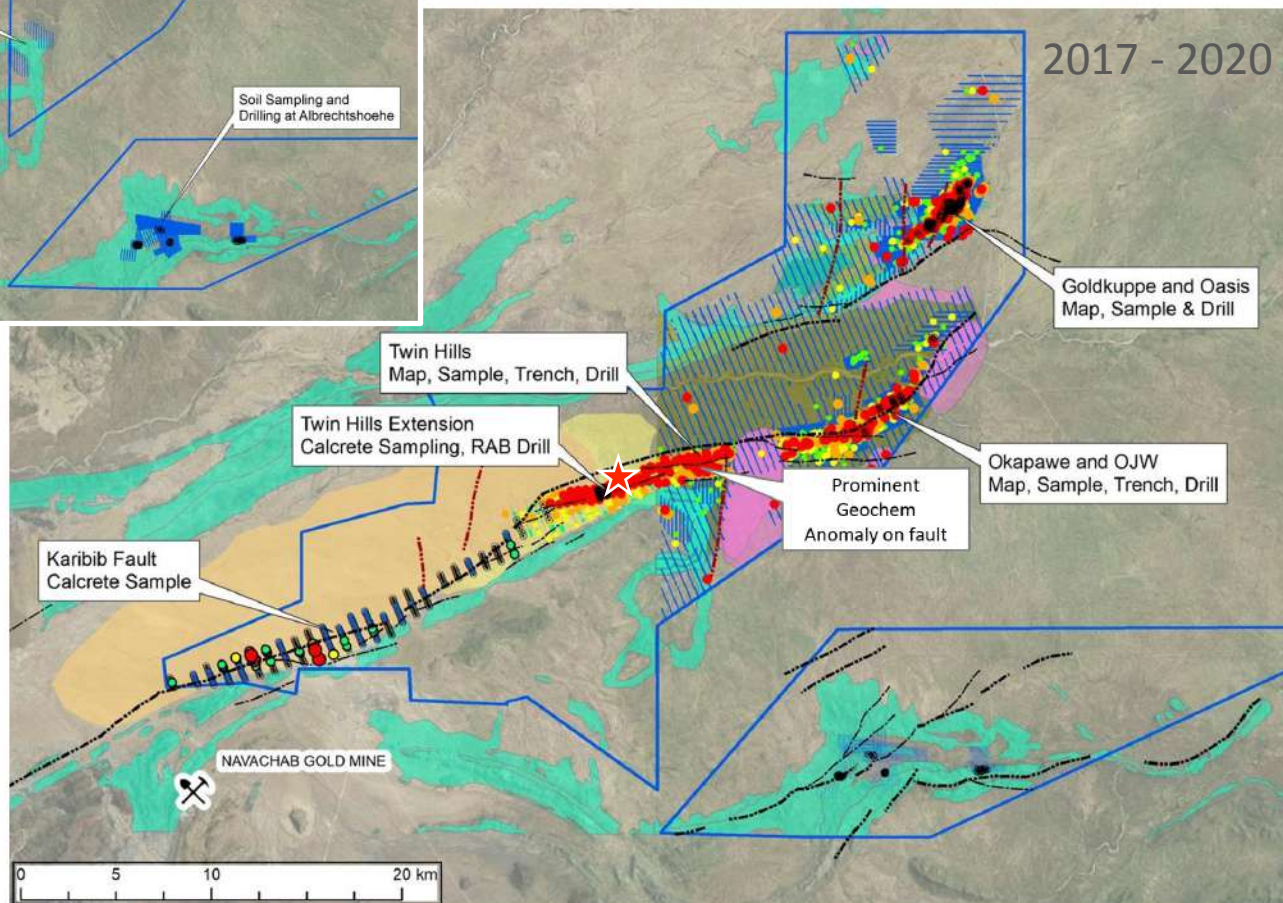

- until 2016:** model-driven exploration with limited success despite significant expenditure by various operators



# Twin Hills within the Karibib Gold District

- **Innovative & systematic exploration** delineated new Au system
- **Twin Hills Au System:** >11km strike, sediment-hosted, structurally controlled hydrothermal Au system with coincident geochem & geophysics in **classic orogenic setting** (source/pathway/trap)
- **Breakthrough discovery at Twin Hills Central & Clouds**  
Wide intercepts incl. high grade = economic scale potential

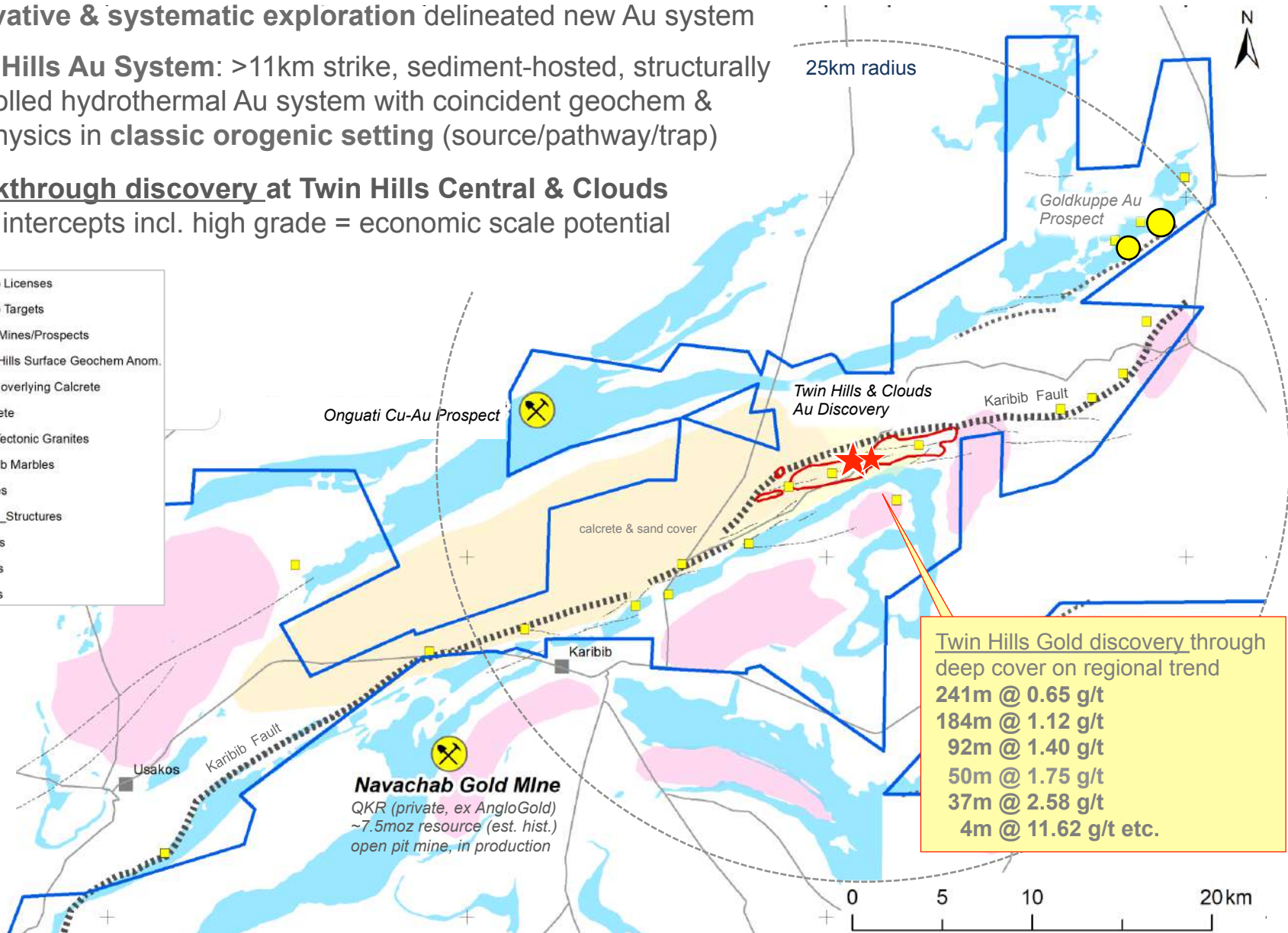

**Twin Hills Gold discovery through deep cover on regional trend**  
 241m @ 0.65 g/t  
 184m @ 1.12 g/t  
 92m @ 1.40 g/t  
 50m @ 1.75 g/t  
 37m @ 2.58 g/t  
 4m @ 11.62 g/t etc.

# Twin Hills & Clouds: Best Drill Results To-Date

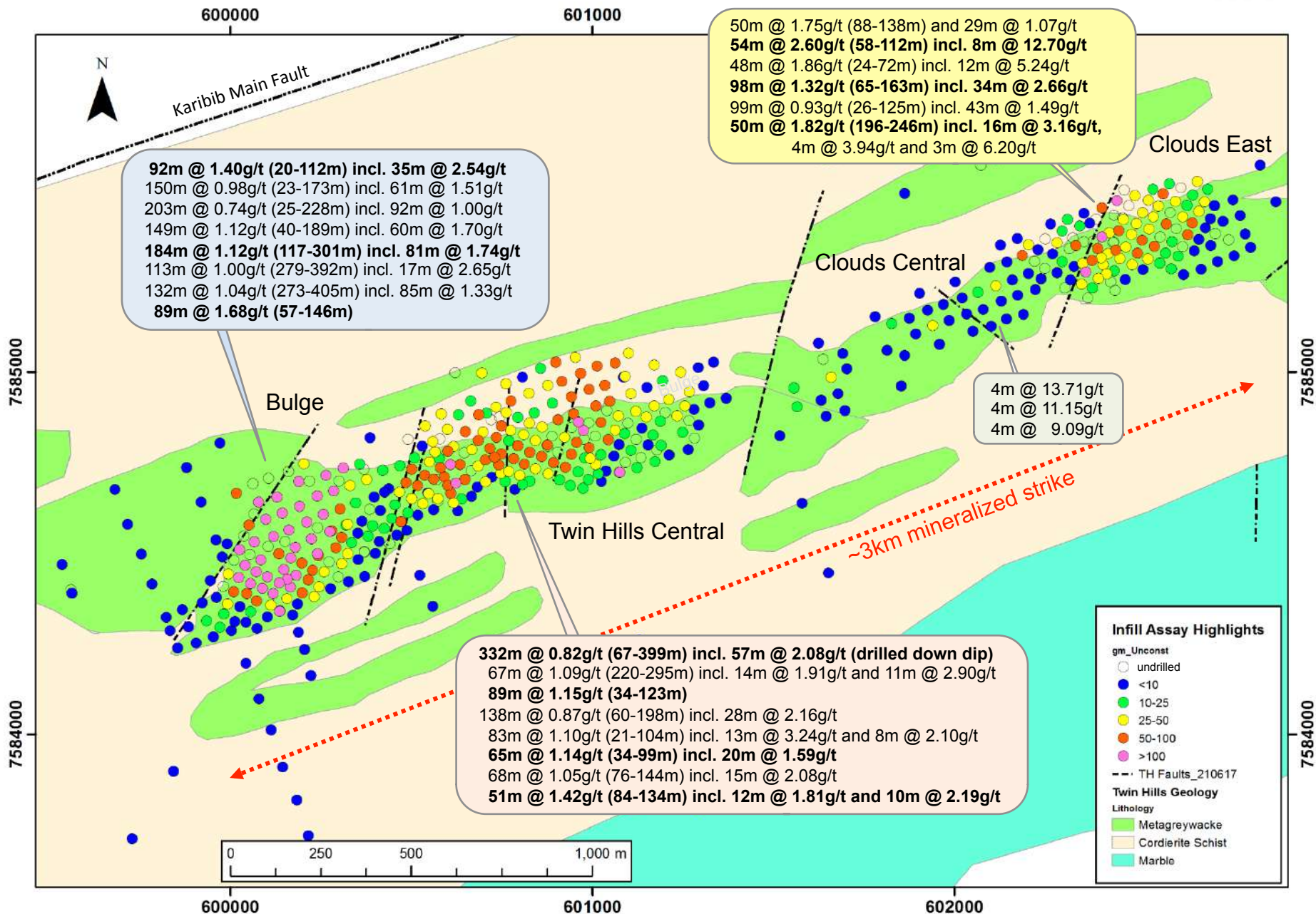

# Typical Deposit Cross-Section (Section 23)

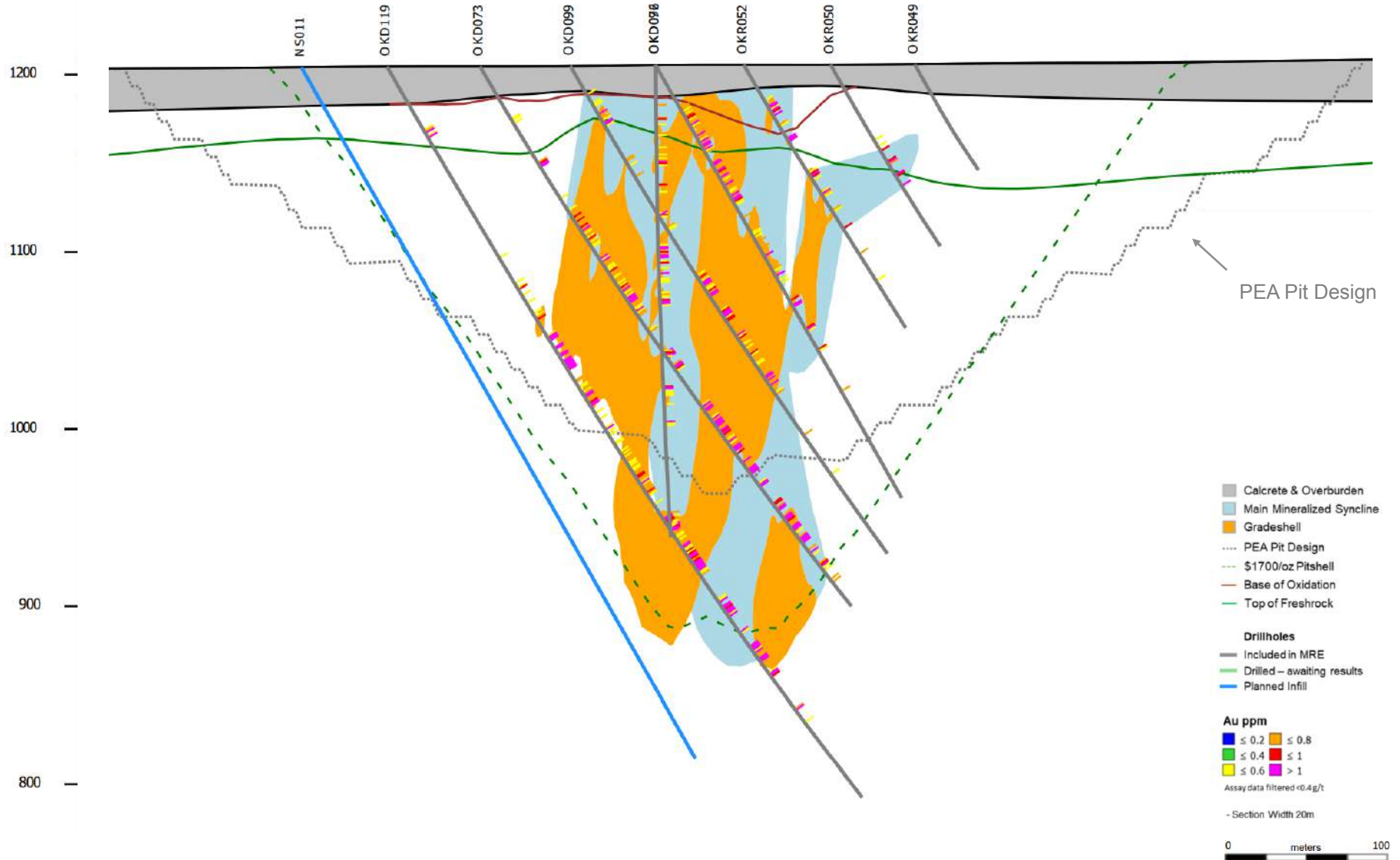



# Geological Setting of the Karibib Area

LITHOLOGY	MEMBER	FORMATION	AGE
			QUARTERNARY
		KUISEB	
		KARIBIB	
	OBERWASSER		
	OKAWAYO	ARANDIS	DAMARA
	SPES BONA		
		CHUOS	
		ETUSIS	
		ABBABIS	KHEISIAN (BASEMENT)

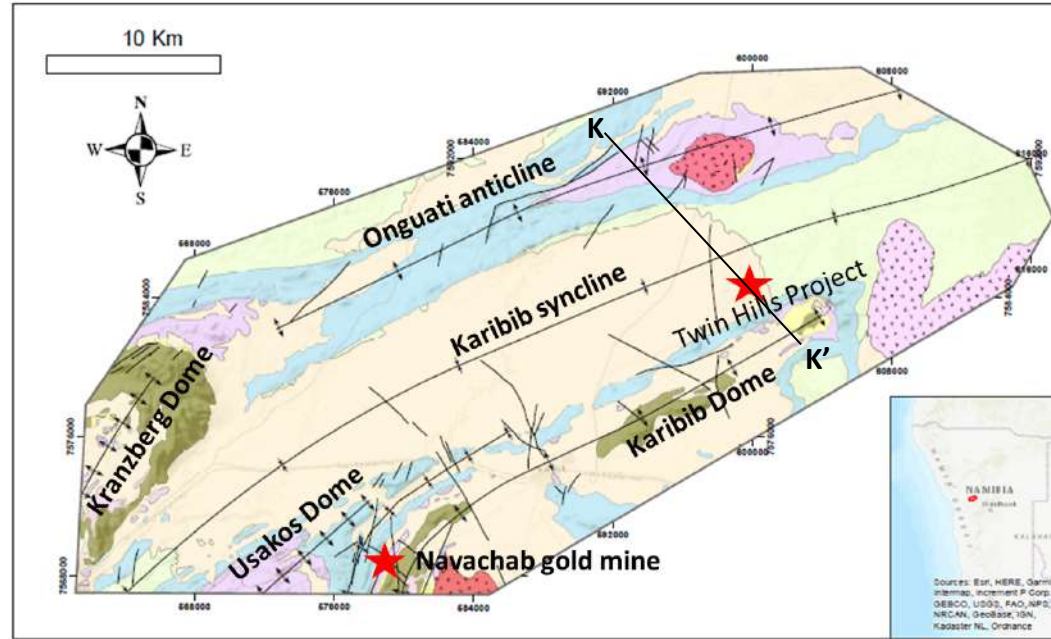

**Legend**

**Structures\_Karibib\_district**

- Anticline
- Syncline
- Structures from GSN

**Granite\_ScZ**

- Late tectonic
- Post tectonic
- Syn tectonic

**Lithology**

- Kuiseb Fm
- Karibib Fm
- Ghaub Fm
- Arandis Fm
- Chuosi Fm
- Etusis Fm
- Abbabis basement
- Calcrete, sand, gravel

Adapted from GSN geological map

**KARIBIB BASIN**

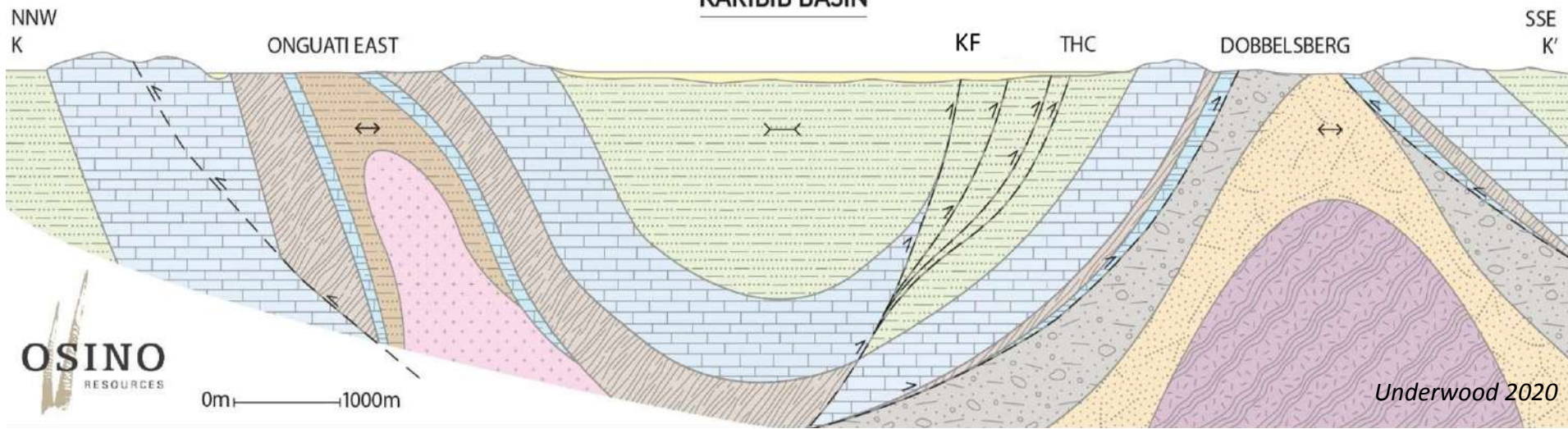



# Cross Section Through Karibib Basin

LITHOLOGY	MEMBER	FORMATION	AGE
			QUARTERNARY
			DAMARA
		KUISEB	
		KARIBIB	DAMARA
	OBERWASSER		
	OKAWAYO	ARANDIS	DAMARA
	SPEBONA		
		CHUJOS	DAMARA
		ETUSIS	
		ABBABIS	KHEISIAN (BASEMENT)

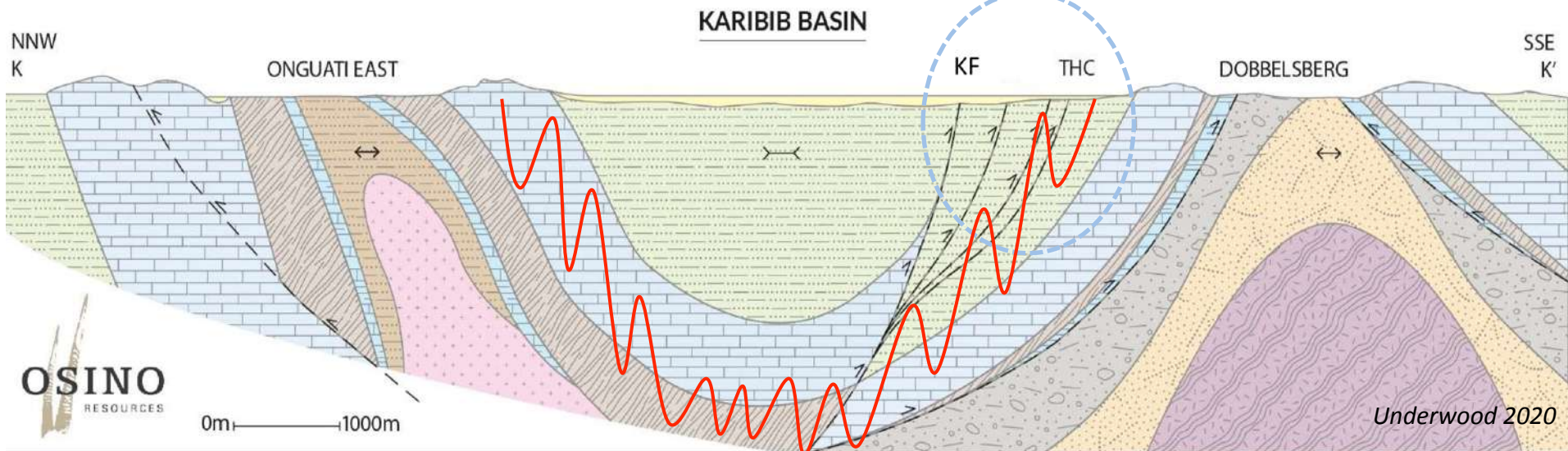
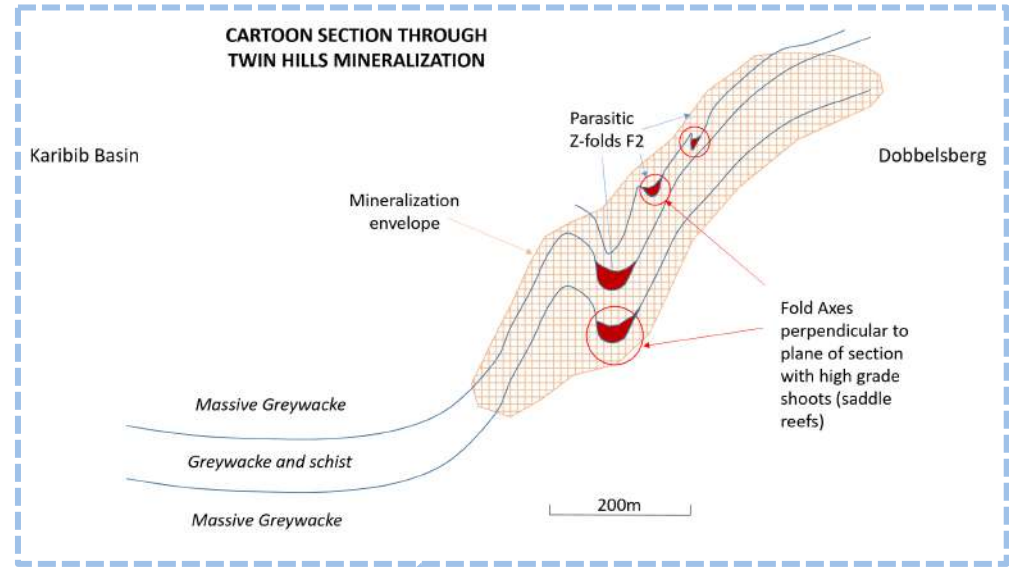

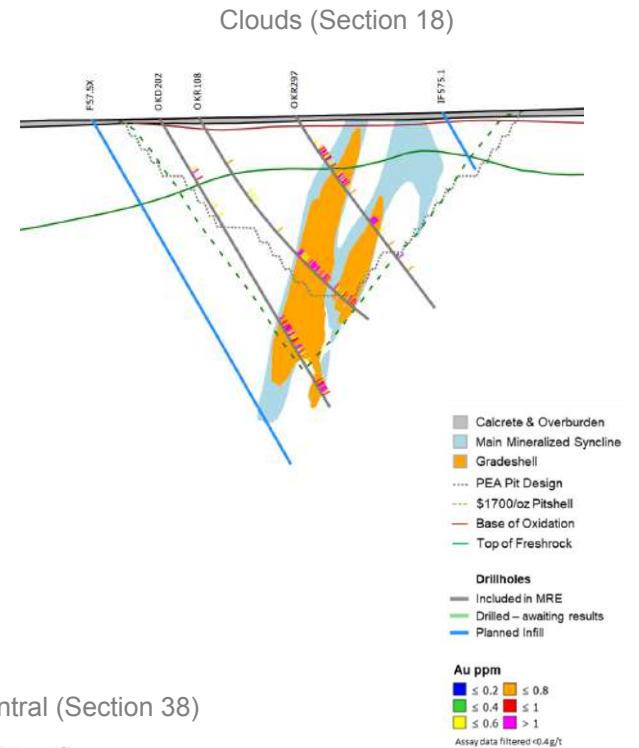
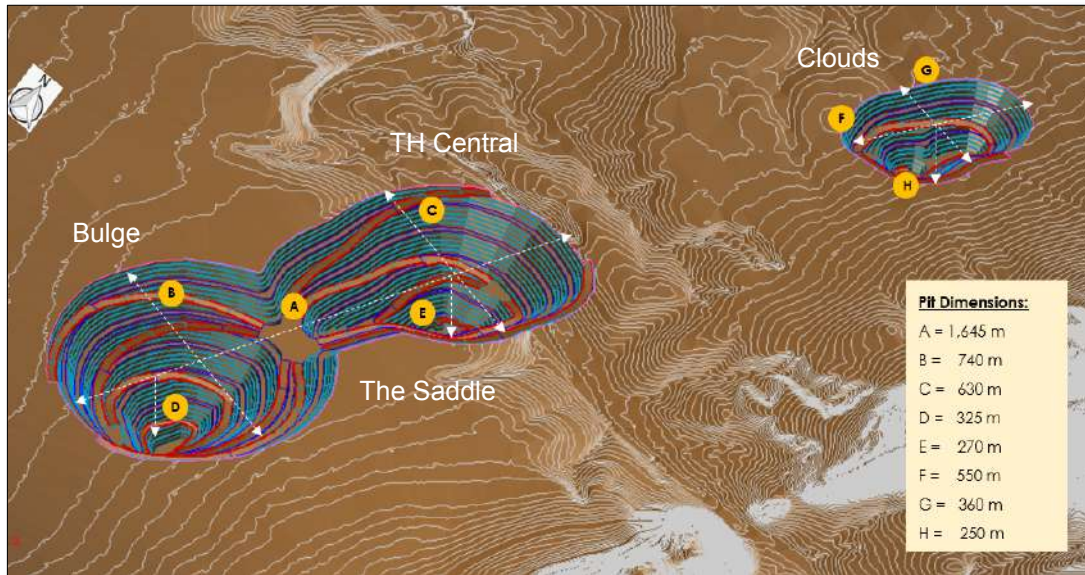

### Bulge (Section 23)

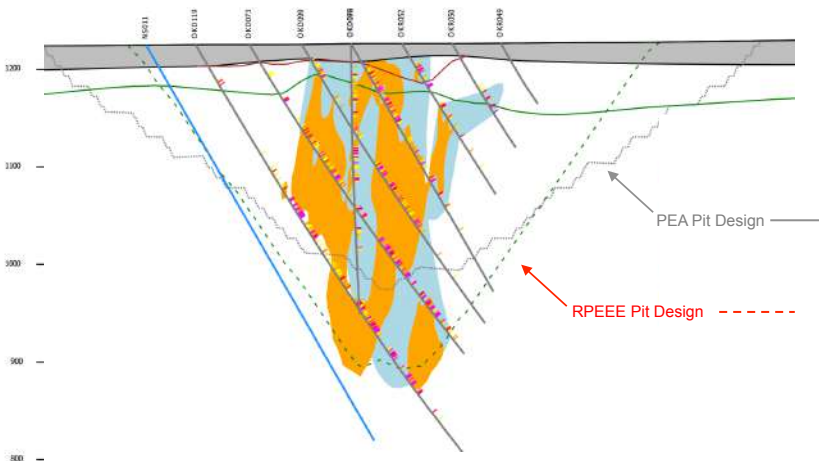

### Twin Hills Central (Section 38)

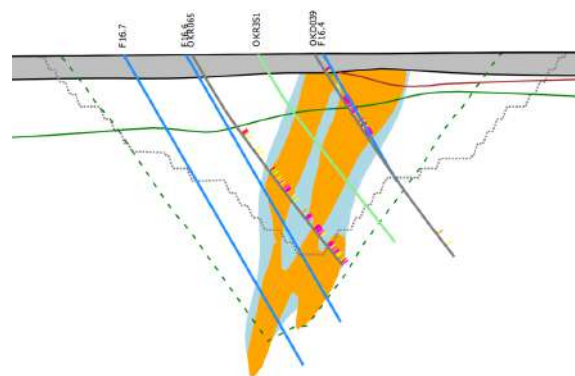

Not to Scale!

# Metallurgical Process Layout

Envisaged circuit layout is 3-stage crushing followed by ball-milling, pre-oxidation and CIL with electrowinning & smelting. Dry stack tailings deposition (likely co-disposal with waste rock) after detox, thickening & filtration.

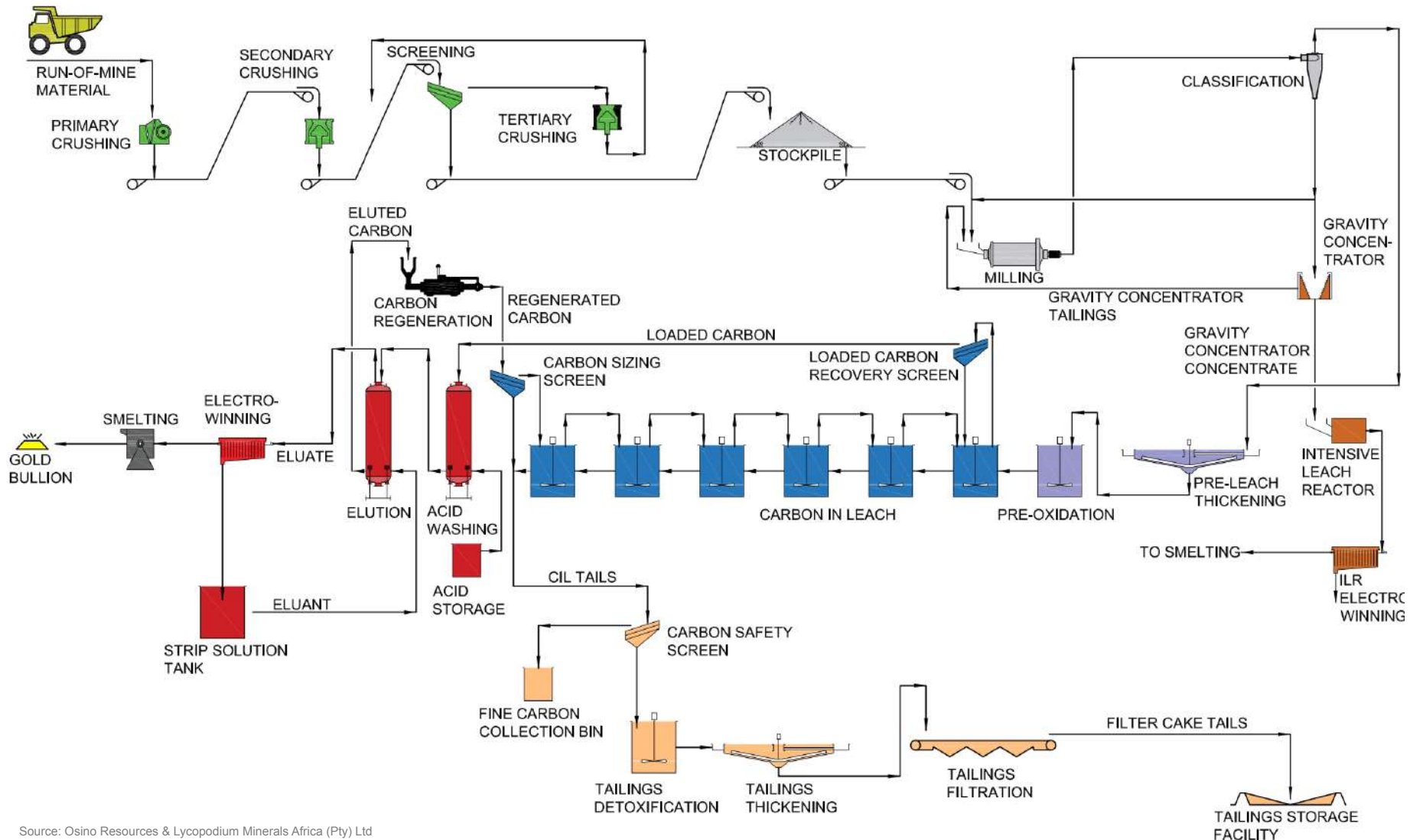



# Typical Namibian Gold Mines

The Town Hills Project is envisaged as a conventional open pit, drill & blast, load & haul, crush, grind, carbon-in-leach processing layout, very similar to the other 2 Namibian gold mines. Navachab and Otjikoto.





# Site Layout

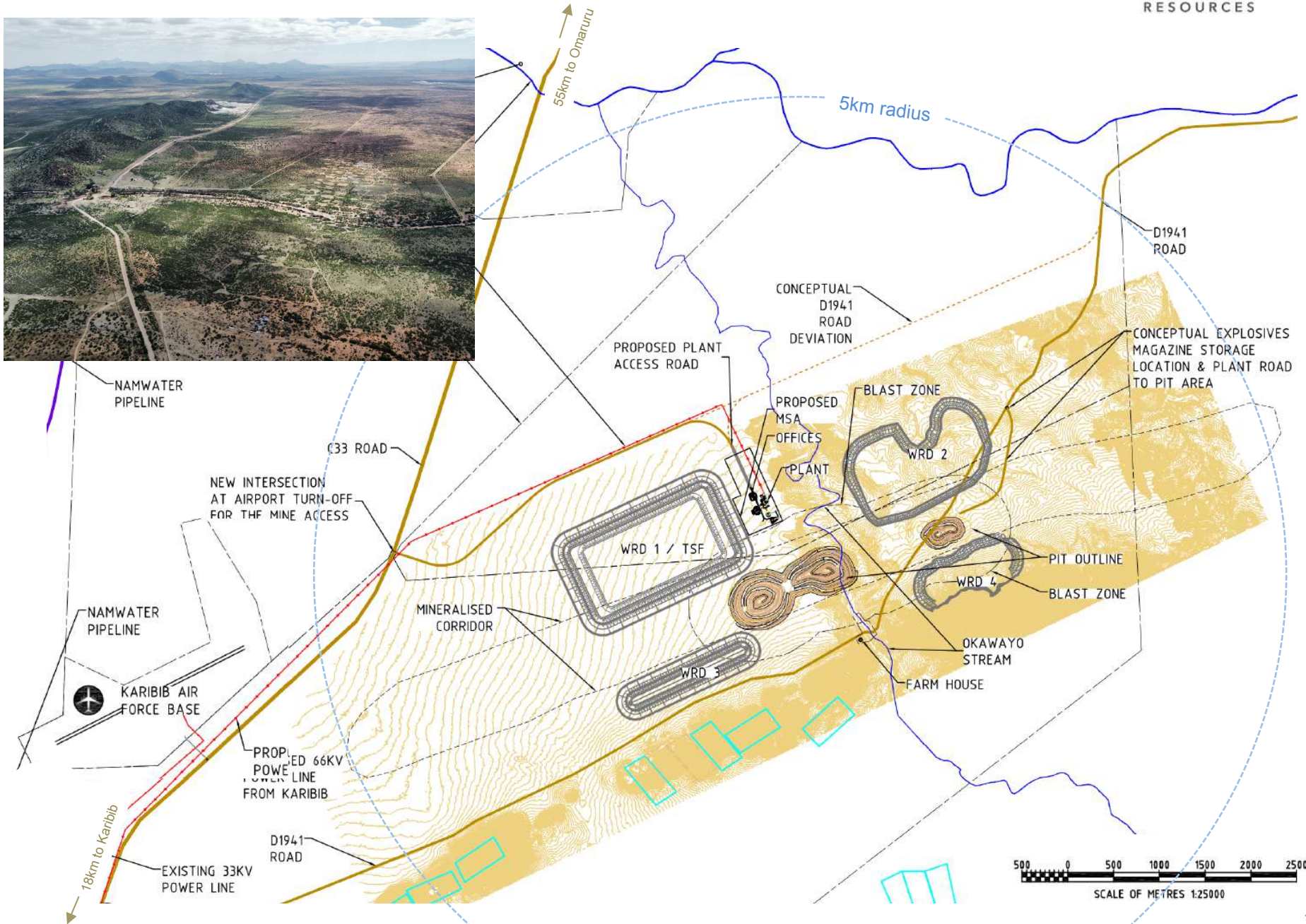

- **Economically viable with attractive returns**
  - 15-year LOM, 3.5mtpa processing capacity with 90.9% average Au recovery.
  - 124,000 ounces Au pa for years 2-5, 99,000 ounces average annual production
  - US\$ 827/oz cash cost, 947 US\$/oz AISC (incl. royalties, levies & sustaining capex)
  - US\$ 176m estimated capital cost (excl. contingency)
- **Low-risk, technically straightforward**
  - Low capital cost & advantageous location (proximity to infrastructure)
  - geologically consistent and simple metallurgy simple
  - no fatal flaws
- **Significant Upside Potential**
  - Additional ounces, improved mine plan & optimised metallurgy

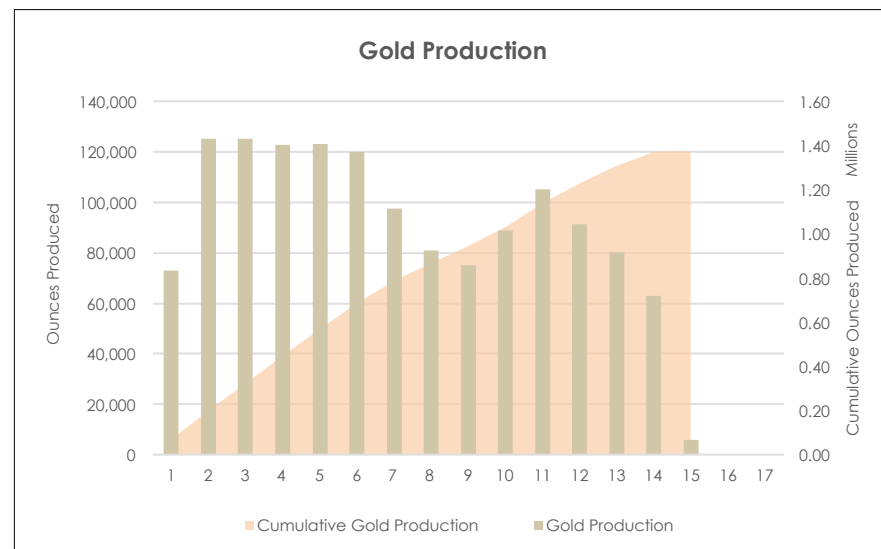
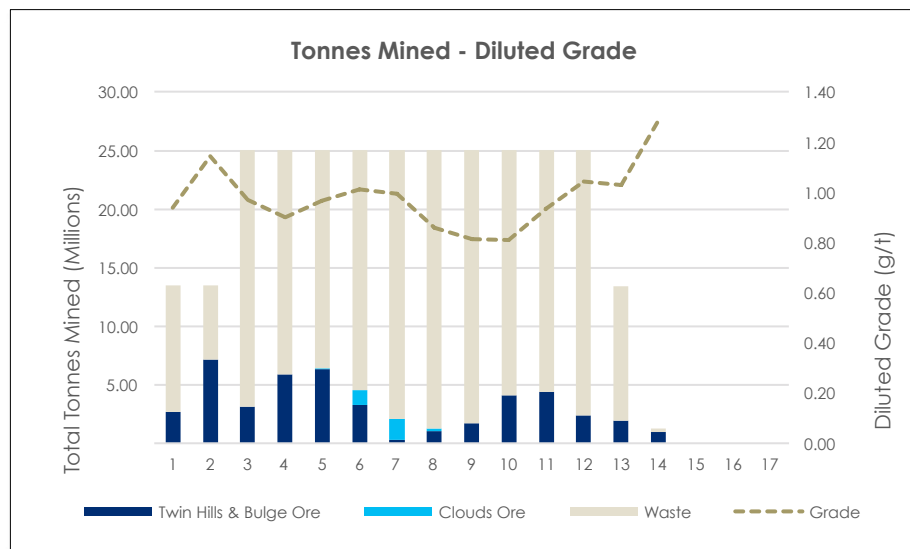



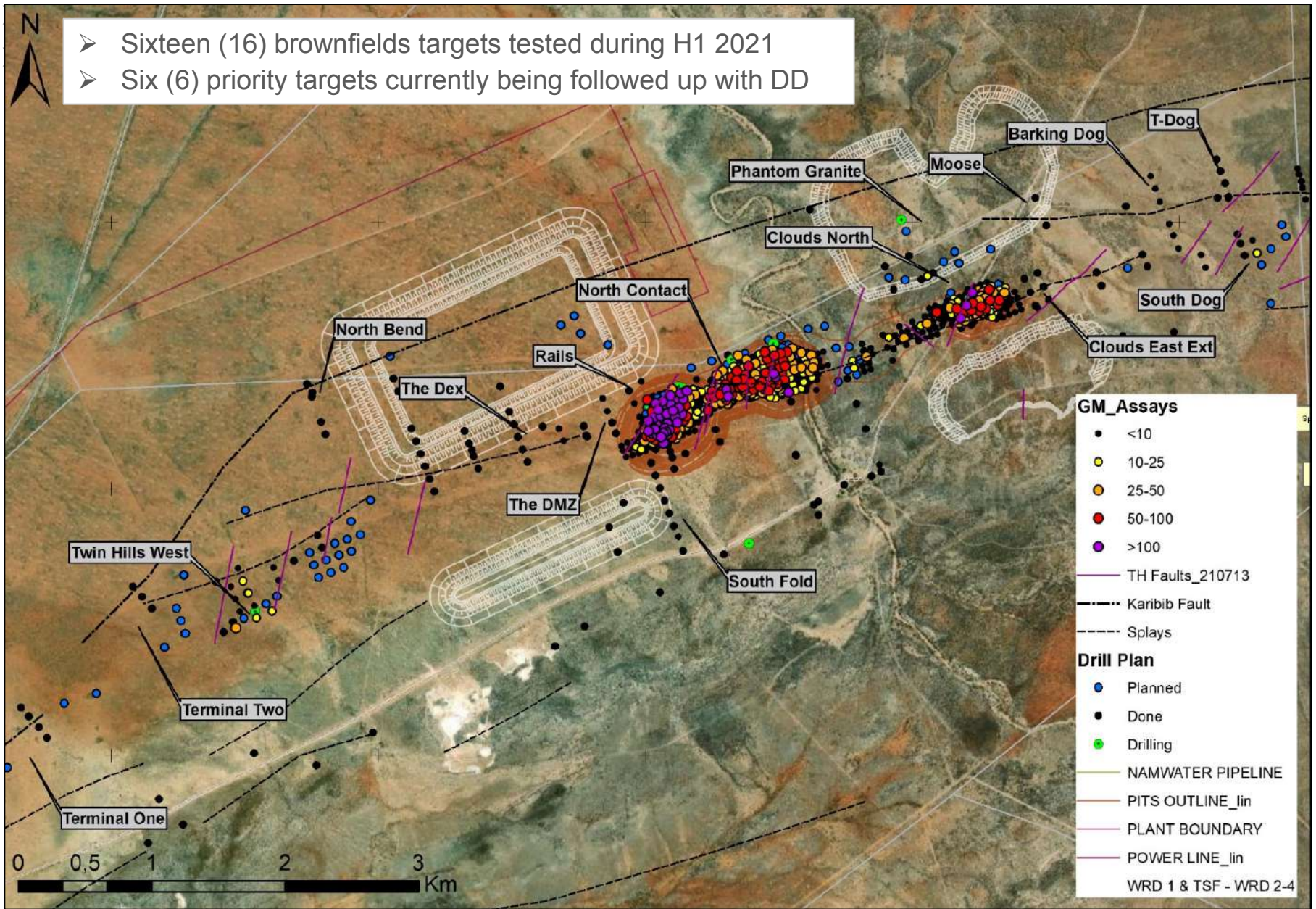



Ongoing, active **resource (expansion & infill) and exploration drill program** in conjunction with fast-tracked **feasibility & project development** to grow Twin Hills and **advance it to construction.**

- |   |              |
|---|--------------|
| 1. Osino formation & commencement of Namibian exploration activities      | 2016         |
| 2. 2016 – 2018 large-scale regional exploration                           | 2017 - 2019  |
| 3. Discovery of Twin Hills Gold Deposit                                   | August 2019  |
| 4. Resource Definition, Growth Drilling & Technical Studies               | 2020 - 2021  |
| 5. Publication of Preliminary Economic Assessment (Pre-feasibility Study) | August 2021  |
| 6. Bankable Feasibility, FEED & Project Financing                         | late H1 2022 |
| 7. Commencement of early works (subject to permitting)                    | late H2 2022 |



# BUILDING VALUE FOR ALL



**FACT SHEET**  
AUGUST 2021

  
**TWIN HILLS**  
TRUST | NAMIBIA



# OSINO

RESOURCES



Thank You!

- ▷ **TSX-V:** OSI
- ▷ **OTC:** OSIIF
- ▷ **FSE:** RSR1

**For more information contact:**  
Heye Daun : President & CEO  
Suite 810 - 789 West Pender Street  
Vancouver, BC V6C 1H2  
[www.osinoresources.com](http://www.osinoresources.com)



- Located along **crustal-scale lineament known as the Karibib Fault**, on southern margin of a turbidite basin folded into a tight syncline during the Damara Orogen
- **11km long system, part of >25km strike length of anomalous geochemistry** along the Karibib Fault; **Au assay values increase towards the southwest**; association with splays and second and third order structures to the south of the Karibib fault
- **Quartz biotite schist-hosted** and associated with hydrothermal alteration assemblage of quartz - sericite - pyrrhotite - arsenopyrite- pyrite
- **High tenor gold anomalies (>100ppb) in calcrete**. Bedrock testing via percussion fence line drilling over high grade calcrete anomaly; tight correlation with surface calcrete values validates the use of **'top of calcrete' as a sample medium**; several bedrock assays over 0.5g/t with a peak value of 2.69g/t
- **Gold anomalies are spatially coincident with magnetic anomalies** in data collected during Q4 2018; causative body for magnetic anomalies is pyrrhotite mineralization in hydrothermally altered quartz biotite schist
- Most prospective portion of TH prospect is a **structural jog on the margin** of the Dobbelsberg dome; **Three magnetic splays**, coincident with anomalous gold assays are visible in the jog, with a combined width of over 1km
- Recent confirmatory work (bedrock percussion drilling) and strike & width expansion was completed before 7-hole diamond drill program resulted in **Twin Hills Central discovery**



Cm-scale quartz sulphide veins in schist



Brecciation and silicification in quartzite



Pyrrhotite in brecciated quartz vein



Arsenopyrite in cm scale veinlet in schist

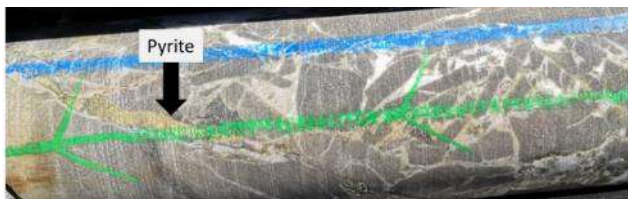

Pyrite on margin of breccia in quartzite

- Sediment-hosted, orogenic (structurally controlled) Au deposit
- Thick package of **turbidites and calcareous sediments** were buried and deformed during the late Proterozoic Damara orogeny
- Metal bearing brines were expelled from the deep **sedimentary basin** and driven towards the southern margin which is defined by a basement cored anticline
- **Hydrothermal fluids** were channelled upwards in the basin margin fault and out into the lower stress splay structures
- **Gold deposition** mainly in a zone of intense **folding and faulting** adjacent to the basin margin.
- **Host rocks** include **biotite and muscovite schist** (Au in quartz - sulphide veins parallel or sub-parallel to foliation) and quartzite and turbidite (Au in breccia, stockwork and cross cutting quartz – sulphide veins)
- **Gold mineralization** is associated with three sulphide phases, namely **pyrrhotite, arsenopyrite and pyrite**
- Several zones of **pervasive alteration and replacement** by silica-rich fluids and sulphides have been intersected. These replacement zones appear to host **higher gold grades**
- Detailed **petrography & mineralogy** samples submitted for better understanding of the Au associations and deportment.

# Major Gold Deposit Types

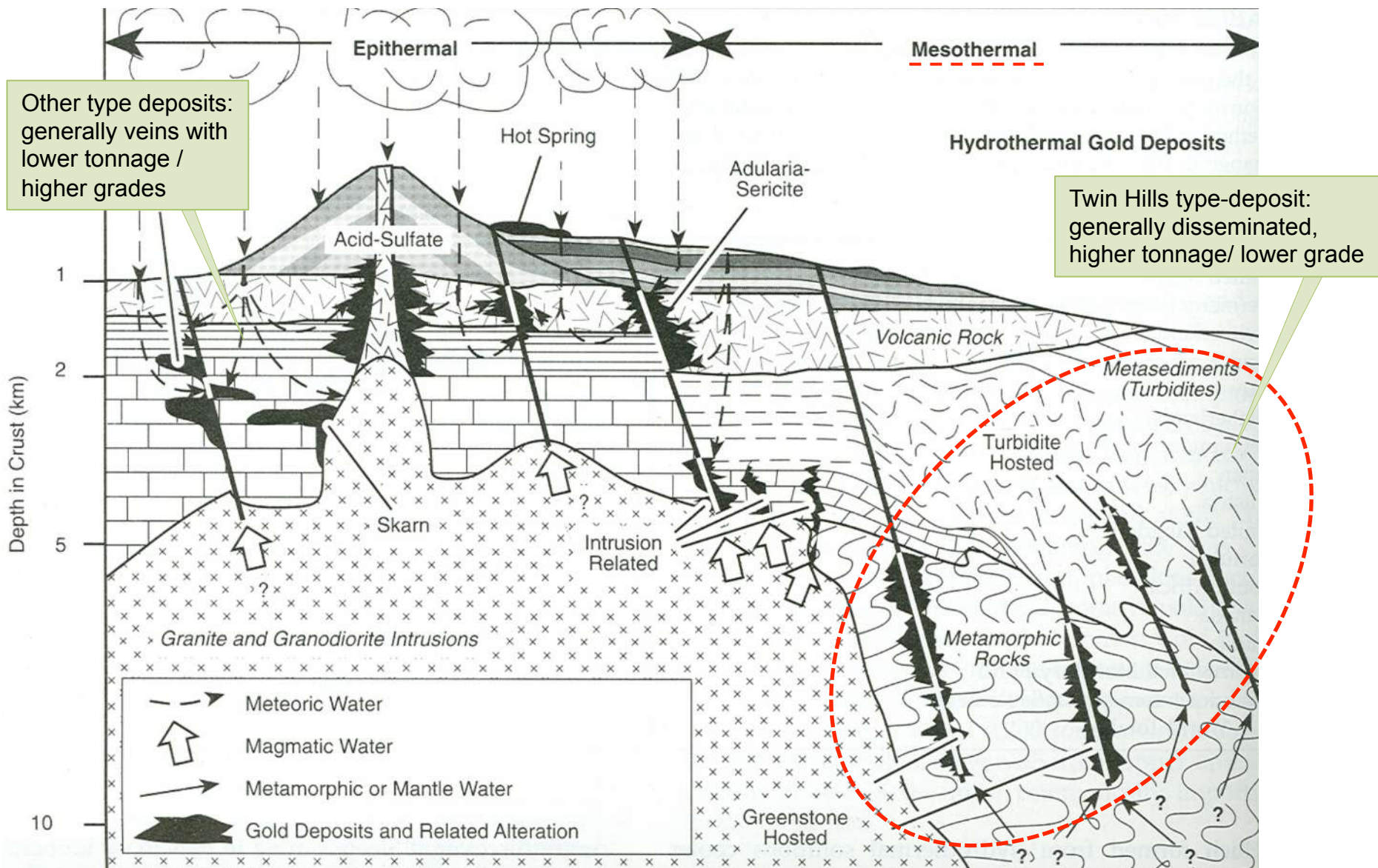

Source: Science Education Resource Centre, Carleton College



# What you can do!

- Provide in writing, any issues and suggestions regarding the proposed development. This correspondence must include:
  1. Name & Surname;
  2. Organization represented;
  3. Position in the organization;
  4. Contact details and;
  5. Any direct business, financial, personal or other interest which you may have in the approval or refusal of the application.
- All initial contributions, comments and concerns must be submitted by 24th September 2021.
- Send written submissions to [info@eccenvironmental.com](mailto:info@eccenvironmental.com)
- Or uploaded onto the ECC website

# Questions / Discussion



Pygmy Falcon  
*Polihierax semitorquatus*



Kobas  
*Cyphostemma currorii*

# Questions / Comments / Concerns

Name / Organisation	Comment / Concern



# Thank You For Your Time!



Contact Us:  
Tel: +264 81 669 7608  
[info@eccenvironmental.com](mailto:info@eccenvironmental.com)

## **- PUBLIC MEETING REPORT (ENGAGEMENTS)**





# ECC

**ENVIRONMENTAL**  
COMPLIANCE CONSULTANCY



ECC-103-332-REP-20-A

## **PUBLIC MEETING'S FEEDBACK**

OSINO RESOURCES' TWIN HILLS GOLD MINE PROJECT, KARIBIB DISTRICT,  
ERONGO REGION, NAMIBIA

*PREPARED FOR*  
*OSINO GOLD EXPLORATION AND MINING (PTY) LTD*

# OSINO

---

RESOURCES

September 2021



## TITLE AND APPROVAL PAGE

**Project Name:** Osino Resources' Twin Hills Gold Mine Project  
**Client Name:** Osino Gold Exploration and Mining (PTY) LTD  
**Ministry Reference:** APP-002920  
**Status of Report:** For external distribution  
**Date of issue:** September 2021  
**Review Period** NA

### ENVIRONMENTAL COMPLIANCE CONSULTANCY CONTACT DETAILS:

We welcome any enquiries regarding this document and its content. Please contact:

**Stephan Bezuidenhout**  
Environmental Consultant & Practitioner  
Tel: +264 81 669 7608  
Email: [stephan@eccenvironmental.com](mailto:stephan@eccenvironmental.com)  
[www.eccenvironmental.com](http://www.eccenvironmental.com)

**Jessica Bezuidenhout (Mooney)**  
Environmental Consultant & Practitioner  
Tel: +264 81 669 7608  
Email: [jessica@eccenvironmental.com](mailto:jessica@eccenvironmental.com)  
[www.eccenvironmental.com](http://www.eccenvironmental.com)

### CONFIDENTIALITY

Environmental Compliance Consultancy Notice: This document is confidential. If you are not the intended recipient, you must not disclose or use the information contained in it. If you have received this document in error, please notify us immediately and delete the document and any attachments. Any personal views or opinions expressed by the writer may not necessarily reflect the views or opinions of Environmental Compliance Consultancy or its client.

*Please note at ECC we care about lessening our footprint on the environment; therefore, all documents are printed double sided.*

## 1 SUMMARY OF COMMENTS FROM I&APS

### 1.1 INTRODUCTION

For the Osino Resources' Twin Hills Gold Mine project, public meetings were scheduled and conducted in the towns of Windhoek, Omaruru and Karibib, from the 31 August to 02 September 2021, as per the advertised in the following newspapers: The Namibian, Sun, Republikein and the Allgemeine Zeitung 18<sup>th</sup> and 25<sup>th</sup> of August 2021.

For the public meetings, local community union representatives, directly affected parties, as well as local, regional and national authorities were identified and invited to attend. All attendees were registered, as interested and affected parties. A summary of the meetings feedback will be issued to the MEFT and relevant competent stakeholders and Interested and Affected Parties (I&APs) to accompany the application for an environmental clearance certificate.

### 1.2 MEETING SUMMARY

Welcoming remarks and public meetings were facilitated by Stephan Bezuidenhout – ECC principal practitioner.

As part of the project's introduction to the public, the project's location, baseline and ESIA process and procedures were discussed.

The meeting covered a detailed description of the public consultation purposes and intention as part of the Environmental Impact Assessment (EIA) process. At this stage I&APs were encouraged and informed of the importance of raising any concerns and comments, which are considered in the EIA studies and submitted along with the final EISA & EMP reports to MEFT and competent authorities.

The components of the environmental assessment at Osino in support of the ESIA were presented, such as, monitoring aspects of ground water, air quality and noise assessments, which form part of the baseline study area with inclusion of additional specialist services which have either been conducted or are in currently in progress.

Technical descriptions of the project, a summary of the geological formations, mineralization, envisioned processing methodology and an overall run of mine was covered by Heye Daun - Co-founder of Osino Resources.

The Twin Hills Gold Mine project found gold mineralization in tectonic faults, which showed viable results as per the drill results illustrated from the year 2016 up to 2021. At this stage, the Osino mine's design and layout, planned construction and start of operation are being considered and under review, for which a pre-feasibility report has been prepared.

A summary of the company's commencement and mineral resources findings since exploration in 2016 were presented. It was presented that Osino's operation currently involves and consists of a team of geologists, engineers, specialist consultants and partners as part of the funding inflow, shareholders and investors. As the project develops, more skilled to semi-skilled opportunities will be created.

The Osino Resources Twin Hills project has a Trust fund, which will be used in the social upliftment and community development programmes. This Trust was set up by Osino Namibia to manage its corporate and social investment activities, which takes its name from the Twin Hills exploration site near Karibib. The trust was funded with N\$ 2 million to invest in the community for education, health and early child development programmes. The funds, which were contributed by the company, are expected to increase as the gold mine project advances. Osino has used this platform to invite service providers, suppliers and business partners to assist in the expansion of activities of this Trust with funding support to uplift the local communities in the surrounding areas of the proposed project and beyond.

### 1.3 KEY FEEDBACK

The comments received from registered I&APs include comments from landowners who neighbour the proposed project site. This group of I&APs presented useful, meaningful and valuable input into the ESIA. Feedback consisted of identification of errors and requests for further information.

The key areas raised from the review can be summarised in the following categories:

- **Constraints of resources and services:** Stakeholders highlighted this to be a concern and wish to be provided with specific measures and plans that the proponent will enforce. The concerns include the issue of water security, potential conflicts with farm owners and co-existence with mining operations in the area, as well as, visual impacts, impacts on biodiversity (fauna and flora) and surface and groundwater.
- **Social impact concerns:** The stakeholders demanded to be informed on further details (i.e. When the Osino operations will commence, provide and create job opportunities for the local community in vicinity of the mining operations, upgrading and developing the local towns of Karibib and Omaruru.



## 2 ACKNOWLEDGEMENTS

ECC would like to thank I&APs for their attendance and providing feedback during the public meetings. The proponent and ECC have endeavoured to address all relevant comments received by I&APs.

ECC further acknowledges that constructive feedback results in a more robust and improved ESIA. This process results in a project that is understood by the community and I&APs. The I&APs feedback has contributed to potential issues or concerns being addressed and to be considered as the project progresses.

Although the official public review period will conclude on the 24<sup>th</sup> September 2021, the proponent and ECC will remain open to continued consultation with I&APs. We look forward to the implementation phase of the project and continued work with all stakeholders.

Lastly ECC would like to thank the proponent for being present at the meetings, considerate and accommodating to the ESIA process and procedures for the proposed project.

### 3 DETAILED COMMENTS AND RESPONSES FROM PUBLIC REVIEW

TABLE 1 – COMMENTS AND FEEDBACK

First Public Meeting Tuesday, <b>31st August</b> 2021, 14h30 Address: 110 Robert Mugabe Avenue, Windhoek Scientific Society			
NO	COMMENT RECEIVED	STAKEHOLDER DETAILS	RESPONSE / CLARIFICATION
1	Since you are at step two of the scoping phase, what are the recognized risks, emergency and fire management procedures at Osino?	Sydney Throne	Osino team: Heye Daun & Wynard Slobbert There is an emergency response currently on site, the project's day to day operation requires an on site risk mitigation, fire extinguishers, fire fighting equipment. The company through its emergency response partnership has provided fire-fighting trainings.
2	<p>Part of the new EIA procedures it is now an obligation that the heritage council is involved in the consent for exploration and mining projects. The competent authorities are being cautious at this stage regarding heritage protection. Has Osino informed the heritage council regarding he project and requested for consent?</p> <hr/> <p>In terms of energy, what energy sources will be considered for the project?</p>	Andreas Simon - MME	<p>Heye Daun: We have done a baseline assessment for the proposed area, which covers the heritage aspects of the site. There are some sites of heritage value already, which were identified and will be handled accordingly.</p> <p>Stephan Bezuidenhout: This is a step that we have considered as part of the EIA; Dr. John Kinahan conducted an archaeological specialist study for this purpose. The archaeological report will be submitted along with the heritage consent application to NHC.</p>

	<p>Advice for Osino to consider becoming energy generators and producers by considering to obtaining the IBP licence to produced own power. In the old model times, there was a single Nampower sell and supply way. But with the current procedures IPP licencing could be obtained and will enable supplying the power back to Nampower.</p>		<p>Heye Daun: Grid power is the most affordable form of energy and conversations are already in discussion with Nampower. Utilizing the new Nampower model might not be ready and in time for operation.</p>
3	<p>Is the project looking into involving specialist in the aspects of managing hazardous and overall the solid waste produced? How will the waste be managed and who is handling the waste, will this be an in house procedure?</p>	<p>Jaco Swartz - Rent a drum</p>	<p>Heye Daun: At the moment the options are to utilize the Walvisbay Hazardous waste facility, a private contractor may be contracted for this. Additionally, the project is still looking into alternatives such as building a landfill and sorting of waste management strategies. Regarding waste such as tailings, a technically feasible and detailed design will be proposed for the site. EPCM contractors will do detailed work and services.</p>
	<p>What would you like us to assess as part of our assessment?</p>	<p>Jessica Bezuidenhout - ECC</p>	<p>Jaco Swartz - Rent a drum: Water is an assessment that needs to be discussed in the reports. From where will the water be sourced?</p> <p>Heye Daun: Some water may be sources from groundwater (sand aquifers), agreement with neighbouring farmers and stakeholders are underway. An abstraction permit shall be submitted to competent authorities for this proposes. The</p>



			<p>company will also be looking at alternatives for water supply aside groundwater abstraction, such as considering (Namwater – as a long term supplier), when considering water demand for the site.</p> <p><b>Sydney Throne:</b> Full established fire services and assessments.</p>
<p>Second Public Meeting Tuesday, 31st August 2021, 18h30 Address: 110 Robert Mugabe Avenue, Windhoek <b>SCIENTIFIC SOCIETY</b></p>			
NO	COMMENT RECEIVED	STAKEHOLDER DETAILS	RESPONSE / CLARIFICATION
	<p>Question on the powerline location and whether the powerline is being included in the linear infrastructure of the project and proposed site?</p> <p>Heye Daun questioned: When is the right time to include the Nampower (grip) line in the layout and obtaining IPP licencing.</p>	<p>Kandara Mukusuka -Nampower</p>	<p>Heye Daun: The proposed powerline may change according to the technical recommendation. Layouts are still changing according to the development of the gold mine project.</p> <p>Jessica Bezuidenhout: The process is ever changing according the projects development and an amendment can be submitted for any changes, which might have not been included in the initial approval.</p> <p>Kandara Mukusuka: For the generation of electricity infrastructure to be included in the Nampower prospects. It would be best to apply for the IPP licence for the generation</p>

			<p>of power now, rather at an early stage.</p> <p>Nampower would suggest that Osino is considering already including the powerline in the layout of the project site. From there different routes could be considered at a later stage.</p>
	<p>What does the Namibia Chamber of Environment (NCE) do and entail?</p>	<p>Heye Daun – Co – founder of Osino</p>	<p>Christopher Brown: To give a brief description, NCE deals with ecology, sociology and resources use aspects in Namibia, it is a council/ organization that works in partnership with other organisations to represent the environmental sector. NCE does interrelate with the government and other parties that can raise funds for its members and that can represent the sector to bring resources to the communities.</p> <p>The environment has always been the drive, for setting up small fund. Help people get funds in and for social developments.</p> <p>Assist where there are systemic failures and strategize on how systematic failures can they be solved. NCE helps with development workshops. Funding comes from large sector corporates and organizations.</p>
	<p>Would like to see a detailed water and visual impacts assessment for this project. Lighting in the areas should be limited to the sites, which may cause disturbance to the neighbouring farms.</p> <p>The Karibib areas have a concentration of migrate birds during</p>	<p>Christopher Brown - NCE</p>	<p>Heye Daun: We take note of that and will provide these notes to the technical and design team to consider these impacts for the final design and reports.</p> <p>Jessica Bezuidenhout: Our team is as well noting this information for the ESIA reports.</p>

	<p>the months of January and February, a variety of birds flock to the area, as part of the study a powerline and infrastructure assessment and designs should be considerate of the risks of birds collision that could results.</p>		
<p>First and Second Public Meeting Wednesday, 01st September 2021, 14h30 &amp; 18h30 Address: Wilhelm Zeraua Rd, Omaruru <b>CENTRAL HOTEL</b></p>			
NO	COMMENT RECEIVED	STAKEHOLDER DETAILS	RESPONSE / CLARIFICATION
	<p>Oisno choose ECC to do an EIA, what is ECC's role in the Osino project; involvement and how many consultants do such environmental impact assessments in Namibia.</p> <p>After the impacts are identified what happens next?</p> <hr/> <p>Jessica Bezuidenhout: Questions why or reasoning for question?</p> <hr/>	<p>Bernd Högel - Farm 54</p>	<p>Stephan Bezuidenhout: ECC's role is to conduct an EIA for Osino. There are a number of consultants, and roughly 50 – 60 adverts go out each month in two local/ national newspapers as per the EIA requirement. Adverts are supposed to be published within two consecutive weeks and there are a number of listed activities that actually require environmental clearance application and registration. Environmental consultants are independent firms that assess impacts as per the Environmental Management Act and regulatory requirements. Any of the concerns raised through the public consultations are added and considered into the EMP and designs of the project as a legal binding document.</p> <p>Heye Daun: Once the impact assessment procedures have been completed, the findings, mitigation and recommendation for compliance are then drafted in the EMP.</p>



			<p>The EMP will be a living document for the company's operation to comply to. This is in progress, however we are currently in the public consultation phase, which is part of the EIA requirements.</p> <hr/> <p>Bernd Hogel: Out of interest of the process.</p>
	<p>Needs clarity on whether the project is in a conservancy or protected area? There is a conservancy somewhere in the area of the proposed project.</p> <p>Will this be included in the assessment and will you look at the impacts to biodiversity to neighbouring areas. Pollution to the grazing animals?</p> <hr/>	<p>Christian Traupe - Omaruru farmers associations</p>	<p>Stephan Bezuidenhout: The nearest conservancy is communal land close to Spitzkoppe, which is 50-60km from the project site. Neighbouring farmers usually come together to form conservancies. We have identified potential and detrimental species that might occur within the mining area. However considering the extent of the project the occurring species, they do tend to move further out of the project site area.</p> <p>Heye Daun: The project is not in a conservancy area. Peter Cunningham who is a specialist that did a study on the fauna and flora in the area, from which we basically identified that there are no level of protected species on the affected farms. The fauna and floral study will be made available to the public for a detailed description.</p> <p>There should be a balance in all operations and impacts should be well managed, of course a mine will always have impacts to the environment but there are economical benefits as well such as such as job creation and creating conservation programmes for neighbouring farms.</p>

			<p>Jessica Bezuidenhout: Such as with B2Gold where a closed community conservation programme was developed to help farmers by creating revenue.</p>
	<p>What is the mine's plan on water resources, where will water be sourced from, this was a question raised in other meetings?</p> <p>Christian Traupe: Water is a problem, debushing is going hand in hand with water levels reduction (it is good project that should be considered in resolving water consumption impact in the area). How many cubic meters per ton will be required for the project?</p> <p>Karibib never had water restriction but this is something that be noted now. There are more people moving and commuting from Omaruru to work in Karibib.</p> <p>Piunus: The other biggest challenges on water, regarding groundwater anticipate acid drainage and pumps failing in the surrounding area due to high abstraction rates? How will the project manage that?</p> <p>Bernd Hogel: There was a lot of water on my farm about 10 years ago and perhaps the Osino operation should do studies to explore north of Karibib close to Navachab. We had almost 4 meter of water and in the last few years there is no water.</p>		<p>Heye Daun: Yes, this is a key issue and we can't rely on a single source of water supply. With drilled boreholes, options are that 1. Groundwater is the first alternative depending on availability; 2. Namwater supply and pipeline connections may be considered for the long-term supply; and 3. Create or build sand aquifers to store and pump water, this may help to reduce water consumption. We have hydrogeological studies for this aspect. Demand side will basically comprise of reducing our water consumption by recycling water in the plant. Other feasible studies are looking at the government desalination plant water supply to project but this may be a long-term vision as it is still underway and may take up. Extensive technical studies are done for the commencement and operation of mine, in the end a best suitable option will be decided for the project. We would have to demonstrate this</p> <hr/> <p>The rule of the thumb is that you need 1.5 million cubic per meter of water consumption. Unit consumption basis is about half then of Otjikoto and Navachab while the production rate will double.</p> <p>Heye Daun: We will not be able to pump or do any water</p>

			abstraction without the appropriate permits from the issuing authorities. The project can positively impact the area and can influence the community in being self sufficient in a lot of supply and demand services.
	<p>What about the air pollution from lead problem? Such as what is happening at Navachab.</p> <p>This will be included in the study and Navachab should be included in this discussion.</p>	Pinias Gurunas	We are not aware of the lead impacts from Navachab but we can communicate to find out from them. Some of the challenges may include acid drainage.
	<p>A couple of years when Osino started operating and the Omaruru community noticed that the people employed by Osino are not from the local town but from all over. This is our biggest concern and a pain to our small town and our local traditional authorities are aware of this.</p> <p>How many people are employed at Osino currently and how many come from Omaruru?</p> <p>When does the project start?</p>	François - Omaruru community development organization	<p>Heye Daun: The company will look into this aspect but the company believes that some employees are recruited from the community. This is always an issue in all towns, while companies look into employing skilled employees for operation and government also expect skilled employees to operate on site. This point is noted of course, not aware how true it can be that Osino has not employed locals. It does not depend on the local sitting of the town but on the availability of skilled workers, so there has to be a balance. Overall this is a big project and will consider all people of all levels.</p> <p>There are people employed from Omaruru and the Omaruru community can contact the Osino office in Omaruru get these numbers and to provide their census finding.</p> <p>At the moment 120 people are employed at Osino, this includes geologists and drillers. How many are exactly from</p>



			Omaruru, we would have to come back on this. The project will only start approximately after 1,5 years of exploration, this was explained earlier in the details of the projects and its funding.
<p>First Public Meeting Thursday, 02nd September 2021, 14h30 Address: 19 Kalk street, <b>KARIBIB TOWN HALL</b></p>			
NO	COMMENT RECEIVED	STAKEHOLDER DETAILS	RESPONSE / CLARIFICATION
	<p>There are a lot of mining operations in these regions but he sees that the community is not regarded in the job opportunity.</p> <p>Wants Osino to be in considerate in their employment opportunities.</p> <p>I will be reporting back about Osino, I acknowledge that they are welcoming and the same was discussed in the meetings all the way from Omaruru to Karibib.</p>	<p>Bernard. U - Traditional Authority representative</p>	<p>Heye Daun: The biggest challenge in employment is mostly the concerns around skilled and unskilled people, but the company is in considerate of all levels of employment. We understand that locals are in need of jobs.</p>
	<p>Will you put up construction camp/ accommodation? Or Where will you put the people employed for the project? At the moment there is no space in Karibib, housing is a major</p>	<p>Hendrick Victorious (owner of hotel)</p>	<p>Heye Daun: There will be some camps placed close to the exploration sites. When construction and operation starts some housing and infrastructures will be build to accommodate the Osino</p>

	issue.		employees in the town of Omaruru and Karibib.
	<p>There will be a lot pressure to the Karibib Town, services and infrastructure. The Karibib Town council would like some insight on whether the trust will consider developing and assisting the town as we can all see that that this is a crucial issue already in the town.</p>	<p>Environmental Health for Karibib Town Council -</p>	<p>Heye Daun: The Osino company is still a small organization to try and solve all existing problems. Moreover, there is currently no inflow of money from operation. However more money is being put in the Trust to help assist the community where possible.</p> <p>It is hard to solve everyone's problem, but we can help people help themselves.</p> <p>Stephan Bezuidenhout: As an addition, a social study was conducted for this project, which will help understand and mitigate some of these community issues at hand.</p>
	<p>Is in agreement of the concerns around employment and that money is always a problem. These are the points that Osino should note:</p> <ol style="list-style-type: none"> <li>1. They do not want the Mine to go to care and maintenance phases. They are promised many things when the mine is opening and they would like to see Osino become a successful mine.</li> <li>2. They want to be informed when the project has been approved and as it progresses.</li> <li>3. The mine must belong to the nation and must be a Namibian mine, we do not want to see other people come in and take all the resources and little benefit will come to Namibia.</li> </ol>	<p>Ambrious March -Usakos</p>	<p>Heye Daun: We believe that this project will be profitable, from the current results and findings. Most people should be able to profit as the project grows but all should be in consideration that this is a small project and organization.</p> <p>All people having given their names in the attendance register will receive notices as the project evolves.</p> <p>We are still at a stage of getting investors and funds to proceed with the project.</p>

	<p>Since you have already started with explorations, how is Osino handling their hydrocarbon spills?</p> <p>You mentioned that you will be 5 meters away from Karibib and main road, how do you intend to resolve concerns on vibrations?</p> <p>Will you be sharing the scoping reports with the public?</p> <p>Appraise working with ECC at an early stage which shows that the Osino people care about the environment.</p>	<p>Vicky - Navachab</p>	<p>Heye Daun: Doc can give a detailed answer and response to this on a one on one basis but mitigation such as drips trays and bunding are used on site. We do have clean up procedure as well.</p> <p>Doc: On hydrocarbon, training and management is ensured on site. There are monthly investigations to manage waste, such as how to dispose and handle. ECC is also a secondary advice organ that is assisting in monitoring.</p> <p>Stephan Bezuidenhout: we take note of your comments and concerns; this is why we hold such meeting to discuss such aspects so that they are included in our assessments.</p> <p>We take note that not all I&amp;APs have emails or access to computers but we will go to the extent of printing the final reports and provide them to locals through town councils and local libraries.</p> <p>Heye Daun: We appreciate that said, not only is Osino working with ECC but with other specialist as well, to deliver the best work.</p>
	<p>Will commercial offices be brought closer to local communities? We would like that Osino considers bringing the</p>	<p>Raymond Tjilongo</p>	<p>Heye Daun: We would like to consider all this input. We have an office based in Omaruru.</p>



	<p>public relation offices should be brought closer to community and within town reach and not only on their operation's site.</p>		
	<ol style="list-style-type: none"> <li>1. Concerns are that when B2Gold opened allot of skilled people flocked from Navachab to B2Gold. Does Osino for-see getting its employees from Navachab? Will the same happen?</li> <li>2. Our schools are producing stars but they do not the resources to developing into their careers. Does Osino have a plan of developing the young through studies and training?</li> <li>3. Concerns that the Karibib town is looked after when the mine becomes operational.</li> </ol>	<p>Bernard. U - Traditional Authority representative</p>	<p>Heye Daun: There is an agreement with chamber of Mines about not getting employees from other mining companies. However, with all that said, it is a free county and people can choose how they would like to. Regarding youth development, yes, there are a number of young people that Osino is funding currently.</p>
	<p>Do you have the list of neighbouring farmers that are residing in the area?</p>	<p>Sarafina Haipinge-MAWLR swk</p>	<p>Stephan Bezuidenhout: Yes, we have a stakeholder list and are willing to share it. Please communicate with us to share this with you.</p>
<p>Second Public Meeting Thursday, 02nd September 2021, 18h30 Address: 19 Kalk street, <b>KARIBIB TOWN HALL</b></p>			

NO	COMMENT RECEIVED	STAKEHOLDER DETAILS	RESPONSE / CLARIFICATION
	<p>Community member of Karibib: Praises Osino for Transparency and going all the way to have all these meetings.</p> <p>Praises that the meeting was positive and well detailed and currently does not have complains or comments at this point. Is there any Co-existence between the farmers and the mine?</p>	<p>G. Geingob – Karibib Town Council</p>	<p>Heye Daun: Negotiation and co-existence is an opportunity that the company is considering. There has to be a way for us to all live together, balance is important.</p>
	<p>We know that we need more people to come in the Karibib Town to develop it. What are your thoughts regarding housing as more people will be flocking to the Karibib town?</p>	<p>Leonard Mbambo - Navachab</p>	<p>Heye Daun: Of course the company has noted this concerns, although the company is small and still developing. We can work together to help one other through the funding programmes.</p> <p>The company would like to see that these projects such as household and services are included in the future plans of the company.</p>
	<p>What happens after the company has finished with the ESIA and EMP? And after the certificate has been received what happens next?</p>	<p>G. Geingob - Karibib Town Council:</p>	<p>Stephan Bezuidenhout: We first provide the reports to the public for review before we submit them to the authorities for a record of decision.</p> <p>Heye Daun: There are a number of listed activities that will be triggered. Once approval is received we will have to start ticking off all the procedures leading up to the construction and opening of the mine.</p>

## APPENDIX A – OFFICIAL PUBLIC INVITATION

# OSINO

RESOURCES

### NOTICE OF AN ENVIRONMENTAL ASSESSMENT AND PUBLIC MEETING OSINO RESOURCES' TWIN HILLS GOLD MINE PROJECT, KARIBIB DISTRICT, ERONGO REGION, NAMIBIA

Environmental Compliance Consultancy Cc. hereby gives notice to all members of the public that an application for an Environmental Clearance Certificate in accordance with the Environmental Management Act, No. 7 of 2007 will be made for gold mining in the Erongo Region. Members of the public are invited to register as an Interested and Affected Party (IAP), attend the first round of public meetings and provide input into the environmental and social impact assessment.

**Applicant:** Osino Gold Exploration and Mining (Pty) Ltd.  
**Environmental Assessment Practitioner (EAP):** Environmental Compliance Consultancy  
**Location:** Erongo Region, Namibia

**Project Title:** Twin Hills Gold Project near Karibib, Erongo Region.  
**Project Location:** 12 km northeast of Karibib, opposite the Karibib Air Base

**Activity:** The proposed project will entail open pit mining by conventional drill & blast, load & haul with a fleet of mobile mining equipment. Gold bearing ore will be processed by crushing, cyanide leaching, carbon-in-pulp (CIP) processing, electrowinning and then smelting in an induction furnace to produce gold bars.

**Public Meetings:**

<b>Windhoek, Tuesday, 31st August 2021</b>	Address: 110 Robert Mugabe Avenue, Windhoek
1. First Meeting:	<b>14:30</b> at the <b>Scientific Society</b>
2. Second Meeting:	<b>18:30</b> at the <b>Scientific Society</b>
<b>Omaruru, Wednesday, 1st September 2021</b>	Address: Wilhelm Zeraua Rd, Omaruru
3. First Meeting:	<b>14:30</b> at the <b>Central Hotel</b>
4. Second Meeting:	<b>18:30</b> at the <b>Central Hotel</b>
<b>Karibib, Thursday, 2nd September 2021</b>	Address: 19 Kalk Street, Karibib
5. First Meeting:	<b>14:30</b> at <b>Karibib Town Hall</b>
6. Second Meeting:	<b>18:30</b> at <b>Karibib Town Hall</b>

**Register & Attend:**

1. Please **register as an IAP**
2. Register for the project at: <https://eccenvironmental.com/projects/> or call ECC to register
3. Registered IAPs will receive a project Background Information Document (BID).

**The closing date to receive written comments and / or concerns will be the 24<sup>th</sup> September 2021.**

In addition to the above meetings, Osino Gold Exploration and Mining (Pty) Ltd are committed to engaging all affected stakeholders through planned, ongoing public participation in the form of focus groups and further meetings as required.

Environmental Compliance Consultancy  
Registration Number: CC/2013/11404  
Members: Mr JS Bezuidenhout or Mrs J Mooney  
PO Box 91193, Klein Windhoek  
Tel: +264 81 669 7608  
E-mail: [info@eccenvironmental.com](mailto:info@eccenvironmental.com)  
Website: <http://www.eccenvironmental.com>  
Project ID: ECC-103-332-ADT-10-A





## APPENDIX B – PUBLIC MEETING ATTENDANCE

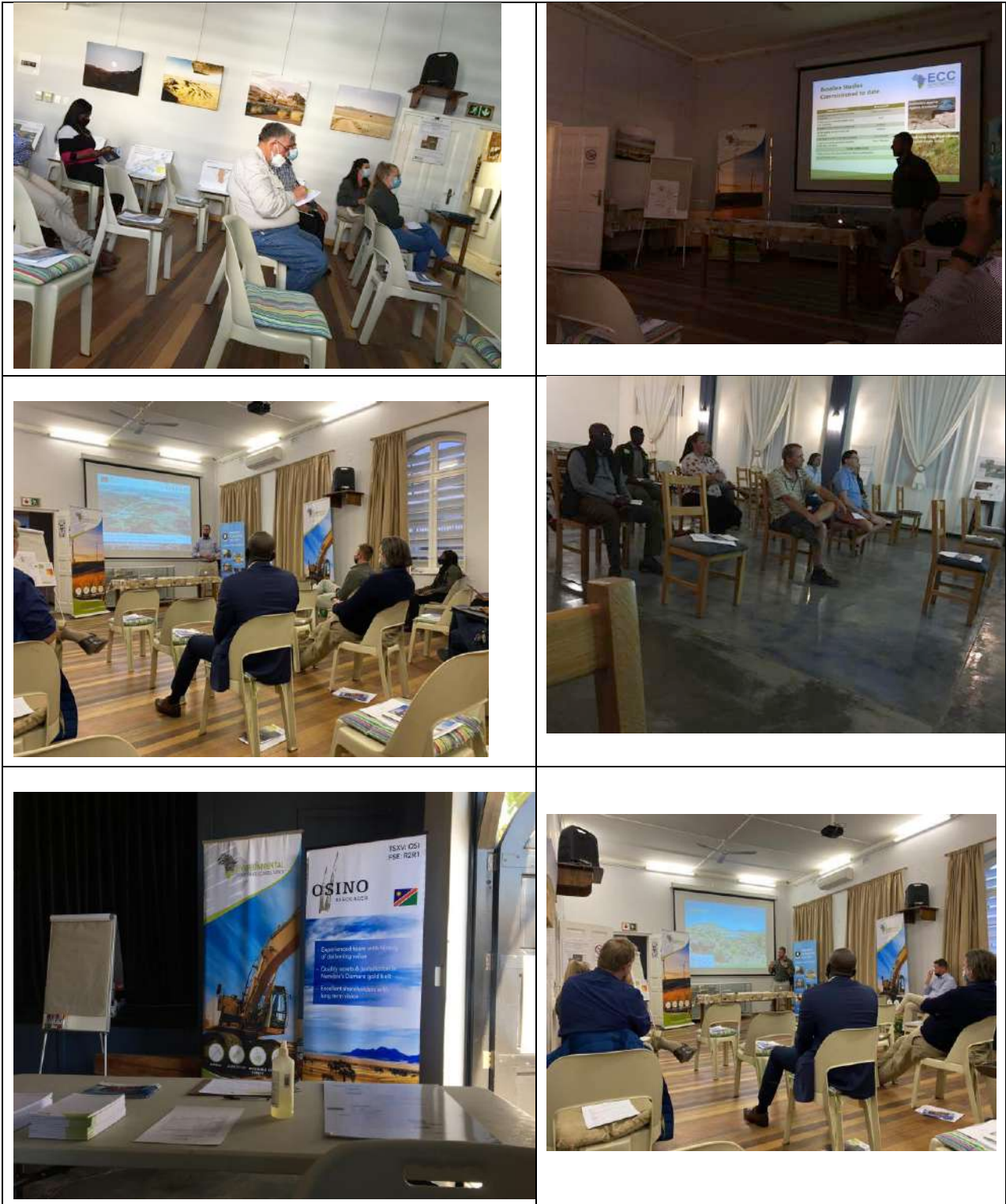

## - LIST OF REGISTERED STAKEHOLDERS

Organization	Surname & First Name
MEFT	Mr Timoteus Mufeti Environmental Commissioner
MME	Mr Erasmus Shivolo Mining Commissioner Senior Private Secretary Ms. Anna Gideon
MAWLR	Mr. Percy W. Misika Executive Director
Erongo Regional Office	Mr Knowledge Ipinge
Omaruru Town Council	"Arno Rahm (new councillor)
Karibib Town Coucil	Mr:Lesley Grand Goreseb - The Chief Executive Officer Mrs Evita Bertoni Personal Assistant to the Chief Executive Officer
NCE	CEO: Dr Chris Brown Office Manager: Ms Henriette Krohne
Chamber of Mines Namibian	"Veston Malango Chief Executive Officer Doreen Meyer Personal Assistant to CEO"
Karibib farmers association	Karibib FA: Chairman – Mr G P van Wyk,  Secretary – Mrs Doris Gladis,
Omaruru farmers assossiation	Omaruru FA: Chairman – Mr Christian Traupe,. Secretary – Mrs Karen Schmidt,
Namibia Heritage Council	Mrs Erica Ndalikokule Mrs Agnes
Development Workshop	Beat Weber (WHK) Sharon !Ganes (Karibib)
BECKER	Heinrich Oskar Rolf Becker
LIEBENBERG	G E
LIEBENBERG	A J
LEISSLER	Rudolf Gerhard Leissler
OTJAKATJONGO LODGE	

OTJAKATJONGO LODGE	
SCHULZ	Berndt Walther Schulz
ADDICKS	Frederick Jacobus Jooste
THOM / STRZELECKI	R M/ S P H
	Andre Van der Walt
WILDFARM OTJIMBOJO CC	
OTJIMBOJO FARMING CC	
OTJIMBOJO FARMING CC	
WALDSCHMIDT	Hilke Waldschmidt
	Dirk Jacobs
HERZBERG	S W
Alexia Properties CC	Wilson Lungu, Manager
Daheim	Manuel De Castro
MEYER	T F L
Karibib Town Council	
DOBBELSBERG (PTY) LTD	Francois Marais
NEUBRUNN CC	
Daheim	Manuel De Castro
HERZBERG	S W
Daheim	Manuel De Castro
HERZBERG	Denis Dausab
BINGER	A E
HERZBERG	S W
GOV OF NAMIBIA	
OLIES	R W A
TWINHILL FARMING (PTY) LTD	(Kobus Coetzee, Farm Manager)
<b>RST Risk and Security Solutions cc</b> Fire Safety and Protection services and compliances.	Sydney Theron
Kindergarten Adventures	Geraldine Neumbo
Man on line investments cc Electrical installation	Robert Mtileni



NGM-GEXOG	Leonard Mbango
Community	Gaingos Elfriede
<b>NamPower</b>  Power utility responsible for supplying electricity to bulk power users including mines	Kandara Mukusuka
Community	Bertha Awases
Senior Public Relations Officer Ministry of Mines and Energy	Andreas Simon
Graduate	Samuel Shinyemba
Legacy Agriculture	Albertine Shipena
Rent-A-Drum	Hilka Kamukuaja
	K. Tjiriange
Rent-A-Drum	Jaco Swart
Phoenix Fire	Stephney Theron
Namibia	Ronald Godo
Private	Silke van Heerden
Private	Reiner
Farmer's Association Omaruru	C. Traupe
Private	Abed
Private	Francois Elvis
Private	Michael . U
	CHRISTIAAN
	Michael
QKR Navachab	Vicky Bauleth
Community	Bianca Foelscher
Otjimbingwe TA	Aluis Gawub
KTC	Saara Ilovu
KTC	Selma Nghifindaka
KTC	Sheva Paulus
Angis Guest House	Andries Pretorius
K.T.C	Melody Gontes
MAWCR	Moses Hanaseb

OWN	Seibeb Sydney
FNB	Uavii Kasale
	Nankudhu
TRADITINA (Name not clear)	Benhard. U
MAWLR- SWK	Sarafina Haipinge
KARIBIB TC	Siefried Au-Khaob
Khan	Henghali Xandre
Community	Page Kapupu
QKR	A. Haseb
Community	P. Seibes
KODO Drilling	Vilho
	Hilma N
KTC	G. Geingob
NGM GEOL	R. Manyanga
NGM HME	A. Kandandu
QKR	L. Iyambo
	Irene Gontes
JET-X	BERITO
Community	Siegfried Gariseb
Community	Kaizer Kalindu
Community	Mico Siwombe
Community	Starlino Kahere
	Daniel Naus-Oab
Omaruru Community Development Organisation	Abed Katonua
	Kalundu Masende Kaizer Kalundu
	Hambeleleni Nghishifola
	Timothy Waendama

**LOG OF ALL COMMENTS AND RESPONSES GENERATED THROUGHOUT PUBLIC CONSULTATION**

NO.	CHAPTER	SECTION	I&AP / STAKEHOLDER COMMENT RECEIVED	STAKEHOLDER DETAILS	RESPONSE / CLARIFICATION
<b>COMMENTS RECEIVED BASED ON THE PUBLIC METING INVITATION, ADVERTS PUBLISHED AND THE BID PROVIDED TO REGISTERED (I&amp;APS)</b>					
1.	-	-	Request for registration  Dear Sir/Madam  Can you please register me as an IAP and share all public documentation with me going forward for Twin Hills gold project  Regards	Israel Kanime  Comment received via email 18/08/2021	Dear Israel Kanime,  Thank you for your registration as an I&AP for the Twin Hills ESIA.  We can confirm your registration, and we will provide all relevant information as we progress. In the meantime, please kindly find enclosed invitation to the upcoming public meetings.  With kind regards, on behalf of the ECC team Jessica
2.	-	-	Environmental safety and rehabilitation after during and after mining.  It is every citizens interest for a growing and strong economy through mining. But taking care and rehabilitation of the environment is very important for the future generations to be able to reuse the environment	Ti Samuel  Comment received via email 18/08/2021	Dear Ti Samuel,  Thank you for your registration as an I&AP for the Twin Hills ESIA.  We can confirm your registration, and we will provide all relevant information as we progress.  With kind regards, on behalf of the ECC team
3	-	-	Fire safety compliant.  Are all the fire and emergency risks addressed? ---	Sydney Theron  Comment received via	Dear Sydney,  Thank you for your registration as an I&AP for the Twin Hills ESIA.

			<p>Gooday Laina,</p> <p>I hereby confirm my attendance for the meeting in Windhoek, 31 August 2021 at 14h30 at the Scientific Society.</p> <p>Regards, Sydney.</p>	email 18/08/2021	<p>We can confirm your registration, and we will provide all relevant information as we progress.</p> <p>With kind regards, on behalf of the ECC team</p>
4	-	-	<p>Power lines routing and servitudes Substation location</p> <p>Any future expansions requiring transmission infrastructure.</p> <p>Any planned embedded generation, capacity, off-takers. Inclusion of the above in ESIA.</p> <p>---</p> <p>Hi Laina,</p> <p>I will attend the 18:30 slot.</p> <p>Kind regards</p>	<p>Kandara Mukusuka</p> <p>Comment received via email 18/08/2021</p>	<p>Dear Kandara Mukusuka</p> <p>Thank you for your registration as an I&amp;AP for the Twin Hills ESIA.</p> <p>We can confirm your registration, and we will provide all relevant information as we progress.</p> <p>With kind regards, on behalf of the ECC team</p>
5	-	-	<p>Request for registration</p> <p>Dear Sir or Madam,</p> <p>I would be most grateful if you would register me and NCE as an I&amp;AP for the Osino Twin Hills EIA and forward me a copy of the BID.</p> <p>Kind regards,</p> <p>Chris</p>	<p>Christopher Brown</p> <p>Comment received via email 18/08/2021</p>	<p>Dear Chris,</p> <p>Thank you for your registration as an I&amp;AP for the Twin Hills ESIA. We register the NCE as an identified interested and affected party for all of our projects in any event, so you are already on the list.</p> <p>We can confirm your registration, and we will provide all relevant information as we progress.</p> <p>In the meantime, please kindly find enclosed invitation to the upcoming public meetings.</p> <p>With kind regards, on behalf of the ECC team.</p> <p>Jessica</p>



6	-	-	<p>Request for registration</p> <p>Location: Karibib</p> <p>Time slot to attend meeting: 18h30</p> <p>In am interested in attending the public meeting, could you please register me as an attendee?</p> <p>Kind regard</p> <p>Geraldine</p>	<p>Geraldine Neumbo</p> <p>Comment received via email &amp; phonecall 24/08/2021</p>	<p>Dear Geraldine Neumbo,</p> <p>Thank you for your call earlier. Please note that you have been registered as an I&amp;AP. We have noted your confirmation of attendance.</p>
7	-	-	<p>Public meeting invite</p> <p>Thank you – will distribute within the MME.</p>	<p>Andreas Simon</p> <p>Comment received via email 25/08/2021</p>	<p>Dear Interested and Affected Party (I&amp;AP),</p> <p>Environmental Compliance Consultancy (ECC) was appointed by Osino Gold Exploration and Mining (Pty) Ltd, to conduct the environmental impact assessments, for the proposed gold mining project near Karibib, in the Erongo Region, Namibia. You have been identified as either a stakeholder/ I&amp;AP, and therefore ECC wishes to invite you, on behalf of the proponent, to the scheduled public meetings, as per the letter herein attached. Please note that the Background Information Document (BID) is also available on the ECC's website for your review and commentary.</p> <p>Kindly access the BID in the link provided below. Link: <a href="https://eccenvironmental.com/download/twin-hills-gold-project-near-karibib/">https://eccenvironmental.com/download/twin-hills-gold-project-near-karibib/</a></p> <p>The closing date to receive written comments and or concerns will be the 24th September 2021. Please RSVP through any of the channels provided and</p>

					confirm your attendance for the public meeting at your most suitable venue, as per the scheduled meetings in the invitation.
8	-	-	Public meeting Dear Laina, Unfortunately, this meeting clashes with my Council /Board meeting tomorrow and thus will not attend. Looking forward to attending the next one. Regards.	Veston Mulango  Comment received via email 30/08/2021	Dear Mr Malango,  Thank you for your email and response. As a registered stakeholder, we will keep you informed as the project progresses. Kind regards
9	-	-	Public meeting Confirming meeting attendance for three people Ambrosius Marsh, Ditto Gonteb, Xandre Hengali	Ambrosius March  Comment received via email 31/08/2021	Registered
10	-	-	Public meeting Confirming meeting attendance	Hilka Hamukuaja  Comment received via email 31/08/2021	Registered
11	-	-	Public meeting Confirming meeting attendance	Raymond Tjiuongua  Comment received via email 31/08/2021	Registered
12	-	-	Public meeting Confirming meeting attendance	Tantago Sylvia Seibes  Comment received via email 31/08/2021	Registered
13	-	-	Public meeting Confirming meeting attendance	Gaingos Elfriede  Comment received via	Registered

				email 31/08/2021	
14	-	-	Public meeting Confirming meeting attendance	Bertha Awases Comment received via phonecall 01/09/2021	Registered
15	-	-	Request for registration Environmental protection/ mining	Toini Shimwandi Comment received via email 01/09/2021	Registered
16	-	-	QKR and Osino will have common interests in Karibib As one of the companies Mining Gold in the Karibib District, we may share and have similar interests	Mclyn Kasale Comment received via email 01/09/2021	Registered
17	-	-	Public meeting Confirming meeting attendance	Bernd Högel Comment received via email 01/09/2021	Registered
18	-	-	I declare that I have no connections with something or someone when making decisions involving them 1. How will you feed the mine with power supply 2. How much water will you use and where will you get water from?	Robert Mtileni Comment received via email 01/09/2021	Yet to respond
19	-	-	Objects of the environmental plans  To attend the event	Leonard Mbango Comment received via	Yet to respond

				email 02/09/2021	
20	-	-	Objects of environmental plan. No comment at the moment.	Selma Kambunga Comment received via email 02/09/2021	Yet to respond
21	-	-	Identified for registration	The Khan River Lodge	Registered
22	-	-	Registered	Hiede Hoffmann Phonecall received 24/09/2021	Registered
<b>COMMENTS RECEIVED BASED ON THE DRAFT SCOPING REPORT AND EMP PROVIDED TO REGISTERED (I&amp;APS)</b>					





Laina Wilhelm <laina@eccenvironmental.com>

## ECC-103-332: NOTICE - Osino Resources' Twin Hills Gold Mine project, Karibib, Erongo Region

18 messages

Laina Wilhelm <laina@eccenvironmental.com>

Mon, Aug 23, 2021 at 12:46 PM

Cc: Jessica Mooney <info@eccenvironmental.com>, Mariska Kuschke <mariska@eccenvironmental.com>, Stephan Bezuidenhout <stephan@eccenvironmental.com>, Jessica Mooney <jessica@eccenvironmental.com>, Philip Hooks <philip@eccenvironmental.com>

Bcc: timoteus.mufeti@met.gov.na, info@mme.gov.na, Anna.Gideon@mme.gov.na, kalom@mawrd.gov.na, cro@erongorc.gov.na, arnowolf@yahoo.com, pa2ceo@karibibtown.org, info@n-c-e.org, info@chamberofmines.org.na, doris@hemconamibia.com, staines@afol.com.na, imbusch@hotmail.co.uk, ombudeli@africaonline.com.na, b.weber@dw-namibia.org, wilz.lungu@yahoo.com, binkivdwest@gmail.com, mar1@africaonline.com.na, goreseb@karibibtown.org, oigroup46@gmail.com, timwaen@gmail.com, sydney.theron@rst.com.na, kandara.mukusuka@nampower.com.na, NCE Admin <admin@n-c-e.org>, Christopher Brown <ceo@n-c-e.org>

Dear Interested and Affected Party (I&AP),

Environmental Compliance Consultancy (ECC) was appointed by Osino Gold Exploration and Mining (Pty) Ltd, to conduct the environmental impact assessments, for the proposed gold mining project near Karibib, in the Erongo Region, Namibia.

You have been identified as either a stakeholder/ I&AP, and therefore ECC wishes to invite you, on behalf of the proponent, to the scheduled public meetings, as per the letter herein attached. Please note that the Background Information Document (BID) is also available on the ECC's website for your review and commentary.

Kindly access the BID in the link provided below.

**Link:** <https://eccenvironmental.com/download/twin-hills-gold-project-near-karibib/>

The closing date to receive written comments and or concerns will be the 24<sup>th</sup> September 2021.

**Please RSVP through any of the channels provided and confirm your attendance for the public meeting at your most suitable venue, as per the scheduled meetings in the invitation.**

On behalf of our team, many thanks.

Kind regards,

**Laina Wilhelm**

**Environmental Compliance Consultancy (ECC)**

Position: Assistant Environmental Practitioner

Office Tel: +264 81 669 7608  
Postal: PO BOX 91193 | Klein Windhoek | Namibia  
Address: 1 Jan Jonker St | Wasserberg Park | Klein Windhoek | Namibia  
Email: [laina@eccenvironmental.com](mailto:laina@eccenvironmental.com)  
Website: [www.eccenvironmental.com](http://www.eccenvironmental.com)



Environmental Compliance Consultancy Notice: This message and any attached files may contain information that is confidential and/or subject of legal privilege intended only for use by the intended recipient. If you are not the intended recipient or the person responsible for delivering the message to the intended recipient, be advised that you have received this message in error and that any dissemination, copying or use of this message or attachment is strictly forbidden, as is the disclosure of the information therein. If you have received this message in error please notify the sender immediately and delete the message.

---

 **ECC-103-332-LET-17-A Osino invite PM public.pdf**  
592K

---

**Christopher Brown** <[ceo@n-c-e.org](mailto:ceo@n-c-e.org)>  
To: Laina Wilhelm <[laina@eccenvironmental.com](mailto:laina@eccenvironmental.com)>  
Cc: "info@eccenvironmental.com" <[info@eccenvironmental.com](mailto:info@eccenvironmental.com)>

Mon, Aug 23, 2021 at 2:01 PM

Dear Laina,

I would like to attend the 14h30 public meeting on 31 August 2021 at the Scientific Society.

Kind regards,

Chris

**Dr Chris Brown**



**20 Nachtigal Street, Ausspannplatz, Windhoek**

**PO Box 40723, Ausspannplatz, Windhoek, Namibia**

**Tel: +264 (0)61 240 140**

**NCE Mobile: +264 (0)81 162 5807**

**e-mail: [ceo@n-c-e.org](mailto:ceo@n-c-e.org)**

[www.n-c-e.org](http://www.n-c-e.org)

**NCE democratizes access to environmental information at [www.the-eis.com](http://www.the-eis.com) - Namibia's one-stop-shop for retrieving, submitting and publishing environmental information**

---

**From:** Laina Wilhelm <[laina@eccenvironmental.com](mailto:laina@eccenvironmental.com)>

**Sent:** Monday, 23 August 2021 12:46

**Cc:** Jessica Mooney <[info@eccenvironmental.com](mailto:info@eccenvironmental.com)>; Mariska Kuschke <[mariska@eccenvironmental.com](mailto:mariska@eccenvironmental.com)>; Stephan Bezuidenhout <[stephan@eccenvironmental.com](mailto:stephan@eccenvironmental.com)>; Jessica Mooney <[jessica@eccenvironmental.com](mailto:jessica@eccenvironmental.com)>; Philip Hooks <[philip@eccenvironmental.com](mailto:philip@eccenvironmental.com)>

**Subject:** ECC-103-332: NOTICE - Osino Resources' Twin Hills Gold Mine project, Karibib, Erongo Region

Dear Interested and Affected Party (I&AP),

Environmental Compliance Consultancy (ECC) was appointed by Osino Gold Exploration and Mining (Pty) Ltd, to conduct the environmental impact assessments, for the proposed gold mining project near Karibib, in the Erongo Region, Namibia.

You have been identified as either a stakeholder/ I&AP, and therefore ECC wishes to invite you, on behalf of the proponent, to the scheduled public meetings, as per the letter herein attached. Please note that the Background Information Document (BID) is also available on the ECC's website for your review and commentary.

Kindly access the BID in the link provided below.

**Link:** <https://eccenvironmental.com/download/twin-hills-gold-project-near-karibib/>

The closing date to receive written comments and or concerns will be the 24<sup>th</sup> September 2021.

**Please RSVP through any of the channels provided and confirm your attendance for the public meeting at your most suitable venue, as per the scheduled meetings in the invitation.**

On behalf of our team, many thanks.

Kind regards,

**Laina Wilhelm**

**Environmental Compliance Consultancy (ECC)**

Position: Assistant Environmental Practitioner

Office Tel: +264 81 669 7608

Postal: PO BOX 91193 | Klein Windhoek | Namibia

Address: [1 Jan Jonker St | Wasserberg Park | Klein Windhoek | Namibia](#)  
Email: [laina@eccenvironmental.com](mailto:laina@eccenvironmental.com)  
Website: [www.eccenvironmental.com](http://www.eccenvironmental.com)

[Quoted text hidden]

[Quoted text hidden]

---

**Laina Wilhelm** <[laina@eccenvironmental.com](mailto:laina@eccenvironmental.com)>  
To: Christopher Brown <[ceo@n-c-e.org](mailto:ceo@n-c-e.org)>  
Cc: "info@eccenvironmental.com" <[info@eccenvironmental.com](mailto:info@eccenvironmental.com)>

Mon, Aug 23, 2021 at 4:02 PM

Dear Chris,

Thank you for your email and response. We have noted your confirmation of attendance.

Kind regards,

**Laina Wilhelm**

**Environmental Compliance Consultancy (ECC)**

Position: Assistant Environmental Practitioner

Office Tel: +264 81 669 7608

Postal: PO BOX 91193 | Klein Windhoek | Namibia

Address: 1 Jan Jonker St | Wasserberg Park | Klein Windhoek | Namibia

Email: [laina@eccenvironmental.com](mailto:laina@eccenvironmental.com)

Website: [www.eccenvironmental.com](http://www.eccenvironmental.com)



Environmental Compliance Consultancy Notice: This message and any attached files may contain information that is confidential and/or subject of legal privilege intended only for use by the intended recipient. If you are not the intended recipient or the person responsible for delivering the message to the intended recipient, be advised that you have received this message in error and that any dissemination, copying or use of this message or attachment is strictly forbidden, as is the disclosure of the information therein. If you have received this message in error please notify the sender immediately and delete the message.

[Quoted text hidden]

---

**Timothy Waendama** <[timwaen@gmail.com](mailto:timwaen@gmail.com)>  
To: Laina Wilhelm <[laina@eccenvironmental.com](mailto:laina@eccenvironmental.com)>

Tue, Aug 24, 2021 at 11:09 AM

Dear Laina

Thank you for the invitation on behalf of Osino Resources Twin Hill Gold Mine Project, Karibib, Erongo Region. I hereby confirm and or make a reservation to attend the scheduled meeting taking place on 31 August 2021 in Windhoek, at 14:30.



Kind regards

Timothy

[Quoted text hidden]

---

**Laina Wilhelm** <laina@eccenvironmental.com>  
To: Timothy Waendama <timwaen@gmail.com>  
Cc: Jessica Mooney <info@eccenvironmental.com>

Tue, Aug 24, 2021 at 12:32 PM

Dear Timothy,

Thank you for your email and response. We have noted your confirmation of attendance.

Kind regards,

**Laina Wilhelm**

**Environmental Compliance Consultancy (ECC)**

Position: Assistant Environmental Practitioner

Office Tel: +264 81 669 7608

Postal: PO BOX 91193 | Klein Windhoek | Namibia

Address: 1 Jan Jonker St | Wasserberg Park | Klein Windhoek | Namibia

Email: [laina@eccenvironmental.com](mailto:laina@eccenvironmental.com)

Website: [www.eccenvironmental.com](http://www.eccenvironmental.com)



Environmental Compliance Consultancy Notice: This message and any attached files may contain information that is confidential and/or subject of legal privilege intended only for use by the intended recipient. If you are not the intended recipient or the person responsible for delivering the message to the intended recipient, be advised that you have received this message in error and that any dissemination, copying or use of this message or attachment is strictly forbidden, as is the disclosure of the information therein. If you have received this message in error please notify the sender immediately and delete the message.

[Quoted text hidden]

---

**Christian Traupe** <imbusch@hotmail.co.uk>  
To: Laina Wilhelm <laina@eccenvironmental.com>

Tue, Aug 24, 2021 at 8:38 PM

I will be attending the meeting in Omaruru 18h30 Central Hotel 1 September ,representing Omaruru Farmers association.

regards

Christian Traupe

---

**From:** Laina Wilhelm <laina@eccenvironmental.com>

**Sent:** Monday, August 23, 2021 10:46 AM

**Cc:** Jessica Mooney <info@eccenvironmental.com>; Mariska Kuschke <mariska@eccenvironmental.com>; Stephan Bezuidenhout <stephan@eccenvironmental.com>; Jessica Mooney <jessica@eccenvironmental.com>; Philip Hooks <philip@eccenvironmental.com>

**Subject:** ECC-103-332: NOTICE - Osino Resources' Twin Hills Gold Mine project, Karibib, Erongo Region

Dear Interested and Affected Party (I&AP),

[Quoted text hidden]

[Quoted text hidden]

---

**Laina Wilhelm** <laina@eccenvironmental.com>  
To: Christian Traupe <imbusch@hotmail.co.uk>  
Cc: Jessica Mooney <info@eccenvironmental.com>

Wed, Aug 25, 2021 at 8:23 AM

Dear Christian Traupe,

Thank you for your email and response. We have noted your confirmation of attendance.

Kind regards,

**Laina Wilhelm**

**Environmental Compliance Consultancy (ECC)**

Position: Assistant Environmental Practitioner

Office Tel: +264 81 669 7608

Postal: PO BOX 91193 | Klein Windhoek | Namibia

Address: 1 Jan Jonker St | Wasserberg Park | Klein Windhoek | Namibia

Email: [laina@eccenvironmental.com](mailto:laina@eccenvironmental.com)

Website: [www.eccenvironmental.com](http://www.eccenvironmental.com)



Environmental Compliance Consultancy Notice: This message and any attached files may contain information that is confidential and/or subject of legal privilege intended only for use by the intended recipient. If you are not the intended recipient or the person responsible for delivering the message to the intended recipient, be advised that you have received this message in error and that any dissemination, copying or use of this message or attachment is strictly forbidden, as is the disclosure of the information therein. If you have received this message in error please notify the sender immediately and delete the message.

[Quoted text hidden]

---

**Christopher Brown** <ceo@n-c-e.org>  
To: Laina Wilhelm <laina@eccenvironmental.com>  
Cc: "info@eccenvironmental.com" <info@eccenvironmental.com>

Wed, Aug 25, 2021 at 4:14 PM

Dear Laina,

I am afraid that I must change my attendance at the public meeting – I will now attend the evening meeting on 31<sup>st</sup> if that is OK. Apologies for this change.

[Quoted text hidden]

Dear Chris,

[Quoted text hidden]

[Quoted text hidden]



[Quoted text hidden]

[Quoted text hidden]

---

**Laina Wilhelm** <laina@eccenvironmental.com>  
To: Christopher Brown <ceo@n-c-e.org>

Wed, Aug 25, 2021 at 4:22 PM

Dear Chris,

Thank you for informing us. That is still alright with us.

[Quoted text hidden]

--

Kind regards,

**Laina Wilhelm**

**Environmental Compliance Consultancy (ECC)**

Position: Assistant Environmental Practitioner

Office Tel: +264 81 669 7608

Postal: PO BOX 91193 | Klein Windhoek | Namibia

Address: 1 Jan Jonker St | Wasserberg Park | Klein Windhoek | Namibia

Email: [laina@eccenvironmental.com](mailto:laina@eccenvironmental.com)

Website: [www.eccenvironmental.com](http://www.eccenvironmental.com)



[Quoted text hidden]

---

**Andreas Simon** <Andreas.Simon@mme.gov.na>  
To: Laina Wilhelm <laina@eccenvironmental.com>

Wed, Aug 25, 2021 at 7:16 PM

Thank you – will distribute within the MME.

**Andreas Simon**

**Senior Public Relations Officer**

**Ministry of Mines and Energy**

**6 Aviation Road**

**Private Bag 13297**

**Windhoek**



**Tel: +264 61 284 8262**

**Fax: +264 61220 386**

**E-mail: [Andreas.Simon@mme.gov.na](mailto:Andreas.Simon@mme.gov.na)**

**website: [www.mme.gov.na](http://www.mme.gov.na)**



**From:** Laina Wilhelm <[laina@eccenvironmental.com](mailto:laina@eccenvironmental.com)>

**Sent:** Monday, 23 August 2021 12:46 PM

**Cc:** Jessica Mooney <[info@eccenvironmental.com](mailto:info@eccenvironmental.com)>; Mariska Kuschke <[mariska@eccenvironmental.com](mailto:mariska@eccenvironmental.com)>; Stephan Bezuidenhout <[stephan@eccenvironmental.com](mailto:stephan@eccenvironmental.com)>; Jessica Mooney <[jessica@eccenvironmental.com](mailto:jessica@eccenvironmental.com)>; Philip Hooks <[philip@eccenvironmental.com](mailto:philip@eccenvironmental.com)>

**Subject:** ECC-103-332: NOTICE - Osino Resources' Twin Hills Gold Mine project, Karibib, Erongo Region

Dear Interested and Affected Party (I&AP),

[Quoted text hidden]

[Quoted text hidden]

The information contained in this e-mail is confidential and may be subject to legal privilege and/or the subject of copyright. If you are not the intended recipient, you must not use, copy, distribute or disclose the e-mail or any part of its contents or take any action in reliance on it. If you have received this e-mail in error, please e-mail the sender by replying to this message. The Government of the Republic of Namibia shall not be held liable for any damages



so caused to the unintended recipient and any unauthorized distribution by the unintended recipient. Any views expressed in this message are those of the individual sender, except where the sender expressly, and with authority, states them to be the views of Government of the Republic of Namibia. Although this email has been checked for viruses and other defects, no responsibility can be accepted for any loss or damage arising from its receipt or use.

---

**Laina Wilhelm** <laina@eccenvironmental.com>  
To: Andreas Simon <Andreas.Simon@mme.gov.na>

Mon, Aug 30, 2021 at 9:11 AM

Dear Andreas,

Thank you for your email. Just a reminder to RSVP for the public meetings scheduled this week.

Kind regards,

**Laina Wilhelm**

**Environmental Compliance Consultancy (ECC)**

Position: Assistant Environmental Practitioner

Office Tel: +264 81 669 7608

Postal: PO BOX 91193 | Klein Windhoek | Namibia

Address: 1 Jan Jonker St | Wasserberg Park | Klein Windhoek | Namibia

Email: [laina@eccenvironmental.com](mailto:laina@eccenvironmental.com)

Website: [www.eccenvironmental.com](http://www.eccenvironmental.com)



Environmental Compliance Consultancy Notice: This message and any attached files may contain information that is confidential and/or subject of legal privilege intended only for use by the intended recipient. If you are not the intended recipient or the person responsible for delivering the message to the intended recipient, be advised that you have received this message in error and that any dissemination, copying or use of this message or attachment is strictly forbidden, as is the disclosure of the information therein. If you have received this message in error please notify the sender immediately and delete the message.

[Quoted text hidden]

---

**Laina Wilhelm** <laina@eccenvironmental.com>

Mon, Aug 30, 2021 at 2:56 PM

Cc: Jessica Mooney <info@eccenvironmental.com>, Mariska Kuschke <mariska@eccenvironmental.com>, Stephan Bezuidenhout <stephan@eccenvironmental.com>, Jessica Mooney <jessica@eccenvironmental.com>, Philip Hooks <philip@eccenvironmental.com>

Bcc: timoteus.mufeti@met.gov.na, Anna.Gideon@mme.gov.na, kalom@mawrd.gov.na, cro@erongorc.gov.na, arnowolf@yahoo.com, pa2ceo@karibibtown.org, info@chamberofmines.org.na, doris@hemconamibia.com, staines@afol.com.na, ombudeli@africaonline.com.na, b.weber@dw-namibia.org, mar1@africaonline.com.na, goreseb@karibibtown.org, oigroup46@gmail.com, sydney.theron@rst.com.na, kandara.mukusuka@nampower.com.na, Veston Malango <vmalango@chamberofmines.org.na>, damian nchindo <damian.nchindo@met.gov.na>, Maria.Amakali@mawf.gov.na, megameno mbwalala <megameno.mbwalala@met.gov.na>, Lely Saima Angula <lse.angula@gmail.com>, EC Secretary <EC.Secretary@met.gov.na>, ps secretary <ps.secretary@met.gov.na>, ED@mawf.gov.na

Good day,

This email serves as a follow-up and reminder to RSVP for the scheduled public meetings for the proposed "Osino Twin Hills Gold Mine project", as per the invitation herein attached. ECC values stakeholder engagement and would like to encourage that either you/ your office and or a representative is present for this meeting.

We look forward to your attendance and hearing from you.

Kind regards,

**Laina Wilhelm**

**Environmental Compliance Consultancy (ECC)**

Position: Assistant Environmental Practitioner  
Office Tel: +264 81 669 7608  
Postal: PO BOX 91193 | Klein Windhoek | Namibia  
Address: 1 Jan Jonker St | Wasserberg Park | Klein Windhoek | Namibia  
Email: [laina@eccenvironmental.com](mailto:laina@eccenvironmental.com)  
Website: [www.eccenvironmental.com](http://www.eccenvironmental.com)



Environmental Compliance Consultancy Notice: This message and any attached files may contain information that is confidential and/or subject of legal privilege intended only for use by the intended recipient. If you are not the intended recipient or the person responsible for delivering the message to the intended recipient, be advised that you have received this message in error and that any dissemination, copying or use of this message or attachment is strictly forbidden, as is the disclosure of the information therein. If you have received this message in error please notify the sender immediately and delete the message.

On Mon, Aug 23, 2021 at 12:46 PM Laina Wilhelm <[laina@eccenvironmental.com](mailto:laina@eccenvironmental.com)> wrote:

[Quoted text hidden]

---

 **ECC-103-332-LET-17-A Osino invite PM public-3.pdf**  
592K

---

**Sydney Theron** <[sydney.theron@rst.com.na](mailto:sydney.theron@rst.com.na)>

Mon, Aug 30, 2021 at 3:19 PM

To: Laina Wilhelm <[laina@eccenvironmental.com](mailto:laina@eccenvironmental.com)>

Cc: Jessica Mooney <[info@eccenvironmental.com](mailto:info@eccenvironmental.com)>, Mariska Kuschke <[mariska@eccenvironmental.com](mailto:mariska@eccenvironmental.com)>, Stephan Bezuidenhout <[stephan@eccenvironmental.com](mailto:stephan@eccenvironmental.com)>, Jessica Mooney <[jessica@eccenvironmental.com](mailto:jessica@eccenvironmental.com)>, Philip Hooks <[philip@eccenvironmental.com](mailto:philip@eccenvironmental.com)>

Gooday Laina,

I hereby confirm my attendance for the meeting in Windhoek, 31 August 2021 at 14h30 at the Scientific Society.

Regards,

Sydney.

---

**From:** Laina Wilhelm <[laina@eccenvironmental.com](mailto:laina@eccenvironmental.com)>

**Sent:** Monday, 30 August 2021 2:56 pm

**Cc:** Jessica Mooney <[info@eccenvironmental.com](mailto:info@eccenvironmental.com)>; Mariska Kuschke <[mariska@eccenvironmental.com](mailto:mariska@eccenvironmental.com)>;  
Stephan Bezuidenhout <[stephan@eccenvironmental.com](mailto:stephan@eccenvironmental.com)>; Jessica Mooney <[jessica@eccenvironmental.com](mailto:jessica@eccenvironmental.com)>;

Philip Hooks <[philip@eccenvironmental.com](mailto:philip@eccenvironmental.com)>

**Subject:** Re: ECC-103-332: NOTICE - Osino Resources' Twin Hills Gold Mine project, Karibib, Erongo Region

Good day,

This email serves as a follow-up and reminder to RSVP for the scheduled public meetings for the proposed "Osino Twin Hills Gold Mine project", as per the invitation herein attached. ECC values stakeholder engagement and would like to encourage that either you/ your office and or a representative is present for this meeting.

We look forward to your attendance and hearing from you.

Kind regards,

**Laina Wilhelm**

**Environmental Compliance Consultancy (ECC)**

Position: Assistant Environmental Practitioner

Office Tel: +264 81 669 7608

Postal: PO BOX 91193 | Klein Windhoek | Namibia

Address: [1 Jan Jonker St](#) | Wasserberg Park | Klein Windhoek | Namibia

Email: [laina@eccenvironmental.com](mailto:laina@eccenvironmental.com)

Website: [www.eccenvironmental.com](http://www.eccenvironmental.com)

Environmental Compliance Consultancy Notice: This message and any attached files may contain information that is confidential and/or subject of legal privilege intended only for use by the intended recipient. If you are not the intended recipient or the person responsible for delivering the message to the intended recipient, be advised that you have received this message in error and that any dissemination, copying or use of this message or attachment is strictly forbidden, as is the disclosure of the information therein. If you have received this message in error please notify the sender immediately and delete the message.

On Mon, Aug 23, 2021 at 12:46 PM Laina Wilhelm <[laina@eccenvironmental.com](mailto:laina@eccenvironmental.com)> wrote:

Dear Interested and Affected Party (I&AP),

Environmental Compliance Consultancy (ECC) was appointed by Osino Gold Exploration and Mining (Pty) Ltd, to conduct the environmental impact assessments, for the proposed gold mining project near Karibib, in the

Erongo Region, Namibia.

You have been identified as either a stakeholder/ I&AP, and therefore ECC wishes to invite you, on behalf of the proponent, to the scheduled public meetings, as per the letter herein attached. Please note that the Background Information Document (BID) is also available on the ECC's website for your review and commentary.

Kindly access the BID in the link provided below.

**Link:** <https://eccenvironmental.com/download/twin-hills-gold-project-near-karibib/>

The closing date to receive written comments and or concerns will be the 24<sup>th</sup> September 2021.

**Please RSVP through any of the channels provided and confirm your attendance for the public meeting at your most suitable venue, as per the scheduled meetings in the invitation.**

On behalf of our team, many thanks.

Kind regards,

**Laina Wilhelm**

**Environmental Compliance Consultancy (ECC)**

Position: Assistant Environmental Practitioner

Office Tel: +264 81 669 7608

Postal: PO BOX 91193 | Klein Windhoek | Namibia

Address: [1 Jan Jonker St](#) | Wasserberg Park | Klein Windhoek | Namibia

Email: [laina@eccenvironmental.com](mailto:laina@eccenvironmental.com)

Website: [www.eccenvironmental.com](http://www.eccenvironmental.com)

[Quoted text hidden]

---

**Veston Malango** <[vmalango@chamberofmines.org.na](mailto:vmalango@chamberofmines.org.na)>

Mon, Aug 30, 2021 at 3:20 PM

To: Laina Wilhelm <[laina@eccenvironmental.com](mailto:laina@eccenvironmental.com)>

Cc: Jessica Mooney <[info@eccenvironmental.com](mailto:info@eccenvironmental.com)>, Mariska Kuschke <[mariska@eccenvironmental.com](mailto:mariska@eccenvironmental.com)>, Stephan Bezuidenhout <[stephan@eccenvironmental.com](mailto:stephan@eccenvironmental.com)>, Jessica Mooney <[jessica@eccenvironmental.com](mailto:jessica@eccenvironmental.com)>, Philip Hooks <[philip@eccenvironmental.com](mailto:philip@eccenvironmental.com)>



Dear Laina,

Unfortunately, this meeting clashes with my Council /Board meeting tomorrow and thus will not attend.

Looking forward to attending the next one.

Regards.



**Veston Malango** | Chief Executive Officer | The Chamber of Mines of Namibia  
P.O. Box 2895, No. 3 Schutzen Street, Windhoek.  
Mobile.: +264 (0) 81 127 6381 | Tel.:+264-61-237 925 | Direct: +264-61-231 480 |  
E-mail: [vmalango@chamberofmines.org.na](mailto:vmalango@chamberofmines.org.na) | <http://www.chamberofmines.org.na>

\*\*\*\*\*

*This email is intended for the named recipient only. It may contain information which is confidential, commercially sensitive, or copyright. If you are not the intended recipient you must not reproduce or distribute any part of the email, disclose its contents, or take any action in reliance. If you have received this email in error, please contact the sender and delete the message. All reasonable precautions have been taken to ensure no viruses are present in this e-mail and the sender cannot accept responsibility for loss or damage arising from the use of this e-mail or attachments.* \*\*\*\*\*

---

**From:** Laina Wilhelm <[laina@eccenvironmental.com](mailto:laina@eccenvironmental.com)>  
**Sent:** Monday, 30 August 2021 14:56  
**Cc:** Jessica Mooney <[info@eccenvironmental.com](mailto:info@eccenvironmental.com)>; Mariska Kuschke <[mariska@eccenvironmental.com](mailto:mariska@eccenvironmental.com)>; Stephan Bezuidenhout <[stephan@eccenvironmental.com](mailto:stephan@eccenvironmental.com)>; Jessica Mooney <[jessica@eccenvironmental.com](mailto:jessica@eccenvironmental.com)>; Philip Hooks <[philip@eccenvironmental.com](mailto:philip@eccenvironmental.com)>  
**Subject:** Re: ECC-103-332: NOTICE - Osino Resources' Twin Hills Gold Mine project, Karibib, Erongo Region

Good day,

[Quoted text hidden]

---

**Mukusuka, Kandara** <[Kandara.Mukusuka@nampower.com.na](mailto:Kandara.Mukusuka@nampower.com.na)> Mon, Aug 30, 2021 at 4:35 PM  
To: Laina Wilhelm <[laina@eccenvironmental.com](mailto:laina@eccenvironmental.com)>  
Cc: Jessica Mooney <[info@eccenvironmental.com](mailto:info@eccenvironmental.com)>, Mariska Kuschke <[mariska@eccenvironmental.com](mailto:mariska@eccenvironmental.com)>, Stephan Bezuidenhout <[stephan@eccenvironmental.com](mailto:stephan@eccenvironmental.com)>, Jessica Mooney <[jessica@eccenvironmental.com](mailto:jessica@eccenvironmental.com)>, Philip Hooks <[philip@eccenvironmental.com](mailto:philip@eccenvironmental.com)>

Hi Laina,

I will attend the 18:30 slot.

Kind regards,

Kandara Mukusuka (Pr.Eng)

Senior Manager I System Security and Planning I Transmission

**Tel:** +264 61 205 2728

**Cell:** +264 81 170 8040

**Email:** [kandara.mukusuka@nampower.com.na](mailto:kandara.mukusuka@nampower.com.na)

**Web:** [www.nampower.com.na](http://www.nampower.com.na)

PO Box 2864, Windhoek, Namibia,

NamPower Control Building, 3 Goethe Street



---

**From:** Laina Wilhelm <[laina@eccenvironmental.com](mailto:laina@eccenvironmental.com)>

**Sent:** 30 August 2021 14:56

**Cc:** Jessica Mooney <[info@eccenvironmental.com](mailto:info@eccenvironmental.com)>; Mariska Kuschke <[mariska@eccenvironmental.com](mailto:mariska@eccenvironmental.com)>;  
Stephan Bezuidenhout <[stephan@eccenvironmental.com](mailto:stephan@eccenvironmental.com)>; Jessica Mooney <[jessica@eccenvironmental.com](mailto:jessica@eccenvironmental.com)>;  
Philip Hooks <[philip@eccenvironmental.com](mailto:philip@eccenvironmental.com)>

**Subject:** Re: ECC-103-332: NOTICE - Osino Resources' Twin Hills Gold Mine project, Karibib, Erongo Region

Good day,

[Quoted text hidden]

---

This Message is subject to the NamPower disclaimer pertaining to electronic communications.

To view the disclaimer visit: <http://www.nampower.com.na/Disclaimer.aspx>

---

**Laina Wilhelm** <[laina@eccenvironmental.com](mailto:laina@eccenvironmental.com)>

Mon, Aug 30, 2021 at 4:49 PM

To: Sydney Theron <[sydney.theron@rst.com.na](mailto:sydney.theron@rst.com.na)>

Cc: Jessica Mooney <[info@eccenvironmental.com](mailto:info@eccenvironmental.com)>, Mariska Kuschke <[mariska@eccenvironmental.com](mailto:mariska@eccenvironmental.com)>

Dear Sydney,

Thank you for your email and confirmation of attendance.

Kind regards,

**Laina Wilhelm**  
**Environmental Compliance Consultancy (ECC)**

Position: Assistant Environmental Practitioner  
Office Tel: +264 81 669 7608  
Postal: PO BOX 91193 | Klein Windhoek | Namibia  
Address: 1 Jan Jonker St | Wasserberg Park | Klein Windhoek | Namibia  
Email: [laina@eccenvironmental.com](mailto:laina@eccenvironmental.com)  
Website: [www.eccenvironmental.com](http://www.eccenvironmental.com)



Environmental Compliance Consultancy Notice: This message and any attached files may contain information that is confidential and/or subject of legal privilege intended only for use by the intended recipient. If you are not the intended recipient or the person responsible for delivering the message to the intended recipient, be advised that you have received this message in error and that any dissemination, copying or use of this message or attachment is strictly forbidden, as is the disclosure of the information therein. If you have received this message in error please notify the sender immediately and delete the message.

[Quoted text hidden]

---

**Laina Wilhelm** <[laina@eccenvironmental.com](mailto:laina@eccenvironmental.com)>

Mon, Aug 30, 2021 at 4:52 PM

To: Veston Malango <[vmalango@chamberofmines.org.na](mailto:vmalango@chamberofmines.org.na)>

Cc: Jessica Mooney <[info@eccenvironmental.com](mailto:info@eccenvironmental.com)>, Mariska Kuschke <[mariska@eccenvironmental.com](mailto:mariska@eccenvironmental.com)>

Dear Mr Malango,

Thank you for your email and response. As a registered stakeholder, we will keep you informed as the project progresses.

Kind regards,

**Laina Wilhelm**

**Environmental Compliance Consultancy (ECC)**

Position: Assistant Environmental Practitioner  
Office Tel: +264 81 669 7608  
Postal: PO BOX 91193 | Klein Windhoek | Namibia  
Address: 1 Jan Jonker St | Wasserberg Park | Klein Windhoek | Namibia  
Email: [laina@eccenvironmental.com](mailto:laina@eccenvironmental.com)  
Website: [www.eccenvironmental.com](http://www.eccenvironmental.com)



Environmental Compliance Consultancy Notice: This message and any attached files may contain information that is confidential and/or subject of legal privilege intended only for use by the intended recipient. If you are not the intended recipient or the person responsible for delivering the message to the intended recipient, be advised that you have received this message in error and that any dissemination, copying or use of this message or attachment is strictly forbidden, as is the disclosure of the information therein. If you have received this message in error please notify the sender immediately and delete the message.

[Quoted text hidden]

**Laina Wilhelm** <laina@eccenvironmental.com>

Mon, Aug 30, 2021 at 4:55 PM

To: "Mukusuka, Kandara" <Kandara.Mukusuka@nampower.com.na>

Cc: Jessica Mooney <info@eccenvironmental.com>, Mariska Kuschke <mariska@eccenvironmental.com>

Dear Kandara Mukusuka,

Thank you for your email and confirmation of attendance.

Kind regards,

**Laina Wilhelm**

**Environmental Compliance Consultancy (ECC)**

Position: Assistant Environmental Practitioner

Office Tel: +264 81 669 7608

Postal: PO BOX 91193 | Klein Windhoek | Namibia

Address: 1 Jan Jonker St | Wasserberg Park | Klein Windhoek | Namibia

Email: [laina@eccenvironmental.com](mailto:laina@eccenvironmental.com)

Website: [www.eccenvironmental.com](http://www.eccenvironmental.com)



Environmental Compliance Consultancy Notice: This message and any attached files may contain information that is confidential and/or subject of legal privilege intended only for use by the intended recipient. If you are not the intended recipient or the person responsible for delivering the message to the intended recipient, be advised that you have received this message in error and that any dissemination, copying or use of this message or attachment is strictly forbidden, as is the disclosure of the information therein. If you have received this message in error please notify the sender immediately and delete the message.

[Quoted text hidden]





REFERENCE: ECC-103-332-LET-17-A  
20<sup>th</sup> August 2021

Identified Stakeholder and/or Potentially Interested Party for:  
Osino Resources' Twin Hills Gold Mine Project, Karibib District

Dear Sir or Madam:

**RE: INVITATION TO A PUBLIC MEETING FOR THE OSINO RESOURCES' TWIN HILLS GOLD MINE PROJECT, KARIBIB DISTRICT IN THE ERONGO REGION.**

Environmental Compliance Consultancy (ECC) on behalf of our client Osino Gold Exploration and Mining (Pty) Ltd hereby notifies you of the upcoming public meetings. ECC is conducting an environmental impact assessment in accordance with the Environmental Management Act, No. 7 of 2007, for which an application for an environmental clearance certificate will be submitted for gold mining in the Erongo Region.

The proposed project will entail open pit mining by conventional drill & blast, load & haul with a fleet of mobile mining equipment. Gold bearing ore will be processed by crushing, cyanide leaching, carbon-in-pulp (CIP) processing, electrowinning and then smelting in an induction furnace to produce gold bars.

This letter is intended to invite and engage stakeholders and potentially Interested and Affected Parties (I&APs) of the proposed project and provide a communication channel with the members of the public and Competent Authorities. You have been identified as either a stakeholder/ I&AP, and therefore ECC wishes to invite you to register and attend the first round of public meetings and provide input to the environmental and social impact assessment (ESIA). Details are provided below:

**Public Meetings:**

**Windhoek, Tuesday, 31st August 2021**

Address: 110 Robert Mugabe Avenue, Windhoek

1. First Meeting: **14:30** at the **Scientific Society**
2. Second Meeting: **18:30** at the **Scientific Society**

**Omaruru, Wednesday, 1st September 2021**

Address: Wilhelm Zeraua Rd, Omaruru

3. First Meeting: **14:30** at the **Central Hotel**
4. Second Meeting: **18:30** at the **Central Hotel**

**Karibib, Thursday, 2<sup>nd</sup> September 2021**

Address: 19 Kalk Street, Karibib

5. First Meeting: **14:30** at **Karibib Town Hall**
6. Second Meeting: **18:30** at **Karibib Town Hall**

Public participation is an important part of the ESIA process, as it allows the public to obtain information about the proposed project. Public participation occurs at various stages throughout a project lifecycle:

1. Please **register as an IAP**
2. Register for the project at: <https://eccenvironmental.com/projects/> or call ECC to register and If you are unable to complete the registration form online please email [info@eccenvironmental.com](mailto:info@eccenvironmental.com) and request an electronic copy of the form that you can complete, sign, scan and return via email to [info@eccenvironmental.com](mailto:info@eccenvironmental.com) to register as an I&AP for the project.
3. Registered I&APs will receive a project Background Information Document (BID).
4. Registered I&APs will also be notified of the draft scoping report for a 7 days comment and review period, once available. During this period the public will have the opportunity to review the draft document and raise any issues or concerns

The closing date to receive written comments and or concerns will be the 24th September 2021.

In addition to the above meetings, Osino Gold Exploration and Mining (Pty) Ltd are committed to engaging all affected stakeholders through planned, ongoing public participation in the form of focus groups and further meetings as required.

Please RSVP through any of the channels provided and confirm your attendance for the public meeting at your most suitable venue, as per the above listed.

ECCs values community input and participation in our projects and we look forward to working with you as the project develops. Should you require further information, please do not hesitate to contact us.

Yours sincerely,



Stephan Bezuidenhout  
**Environmental Compliance Consultancy**  
Contact: 081 669 7608  
Email: [stephan@eccenvironmental.com](mailto:stephan@eccenvironmental.com)



Jessica Bezuidenhout Mooney  
**Environmental Compliance Consultancy**  
Contact: 081 669 7608  
Email: [jessica@eccenvironmental.com](mailto:jessica@eccenvironmental.com)

✉ info@eccenvironmental.com  
 🌐 www.eccenvironmental.com  
 📞 +264812627872  
 📱 +264816531214



Meeting Attendance Register

Date: 31/08/2021

Meeting Subject: - OSINO PUBLIC MEETING Time 18:30

Venue: NAMIBIA SCIENTIFIC SOCIETY

	NAME	ORGANIZATION	EMAIL ADDRESS	CONTACT NUMBER	SIGNATURE
1	KANDARA mukusuka	NAMPPOWER	kandaramukusuka@nampower.com.na	0811705040	<i>[Signature]</i>
2	Chris Brown	NCE	ceo@n-c-e.org	+264 61 240 140	<i>[Signature]</i>
3					
4					
5					
6					
7					
8					
9					
10					
11					



✉ info@eccenvironmental.com  
 🌐 www.eccenvironmental.com  
 📞 +264812627872  
 📞 +264816531214



Meeting Attendance Register

Date: 31/8/2021

Meeting Subject: - Osino Public Meeting - Windhoek Time 14:30

Venue: Namibian Scientific Society

	NAME	ORGANIZATION	EMAIL ADDRESS	CONTACT NUMBER	SIGNATURE
1	Sydney Theron	RST	sydney.theron@rst.com.na	+264 81 221 368	<i>Theron</i>
2	Ronald Godo	NAMIBIA	roald@igiconstruction.net	+264 81 243576	<i>God</i>
3	Samuel Shinyeuba	Graduate	SamuelShinyeuba3@gmail	+26 4814765261	<i>Shinyeuba</i>
4	Albertine Shipena	Legacy Agriculture	shipenaempire@gmail.com	0855510271	<i>Shipena</i>
5	Klison Lungu	Alexia Properties	wilsonlungu@protonmail.com	0818117919	<i>Lungu</i>
6	Hilka Hamakupa	Rent-A-Drum	Pr@rent-a-drum.com.na	0811277917	<i>Hamakupa</i>
7	K. J. Rlange		Jwra73@gmail	081495677	<i>KJR</i>
8	Jaco Swart	Rent-A-Drum	cm@rent-a-drum.com.na	0812770520	<i>Swart</i>
9	A. Simon	NME	Andreas.Simon@nma.gov.na	0813863155	<i>Simon</i>
10	Stephney Theron	Phoenix Fire	stephneytheron@yahoo.com	0818014480	<i>Theron</i>
11					

✉ info@eccenvironmental.com  
 🌐 www.eccenvironmental.com  
 📞 +264812627872  
 📠 +264816531214



Meeting Attendance Register

Date: 01-Sept. 21

Meeting Subject: - Osino Twin Hills - Public Meeting @ 14:30 & 18:30

Venue: Omaruru

	NAME	ORGANIZATION	EMAIL ADDRESS	CONTACT NUMBER	SIGNATURE
1	Silke van Heerden	Private	namibiatrophy@gmail.com	081 274 8771	
2	Reiner	Private	Labredorning09@gmail	0812516552	
3	Malakia Immanuel	OSINO	miindomboje@gmail.com	0812151276	
4	TUUMA NDEVAETELA	OSINO	tndevaela@etresources	0817001285	
5	Pinias Gurubos	OSINO	Mikepinias@hotmail.com	0813125315	
6	L. TRAMPE	FARMERS ASS OMARURU	jimbusch@hotmail.co.uk	0812555149	
7	Bernad Hogel	Okajo/Farm karibib	peterbeck@manx.net	0815844732	
8	Abel	Private	-	0816645467	
9	Francois	Private	Francoiselvis87@gmail.com	0812838011	
10	Michael-U	Private	uasorau@gmail.com	0812508198	
11					



✉ info@eccenvironmental.com  
 🌐 www.eccenvironmental.com  
 📞 +264812627872  
 📠 +264816531214



Meeting Attendance Register

Date: 02 - Sept. 21

Meeting Subject: - Osino Twin Hills Gold Mine Project - Public Meeting  
 Venue: Karibib Town Hall @ 13:30

	NAME	ORGANIZATION	EMAIL ADDRESS	CONTACT NUMBER	SIGNATURE
1	Hilma N		skandiwapa81@gmail.com	0811555745	
2	Wynard Slobbat		wslobbat@osinoreources.com	0816310488	
3	Piet Surt	ECC	piet@eccenvironmental	0817063051	
4	G. GEINGOB	KTC	ggr-geingob@karibibtown.org	0814673048	
5	R. MAMYANGA	NGM GEOL	Richard.Mamyang@navachab.com.na	0813590709	
6	A. Kandanda	NGM HMT	anton.kandanda@navachab.com.na	0811246984	
7	L. ILAMBO	@HR	neema940@gmail.com	0813620468	
8	Irene Gontes		igontes76@gmail.com	0812899179	
9	Geraldine Neumbo	Kindergarten Adventurers	gerladinen@gmail.com	0813138506	
10	BENITO	JET X	karibib@fpdt.na	0816471977	
11	LEONARDO MMBANGO	NGM - GEOL	Leonard.Mbango@navachab.com.na	0812997277	

✉ info@eccenvironmental.com  
 🌐 www.eccenvironmental.com  
 📞 +264812627872  
 📱 +264816531214



Meeting Attendance Register

Date: 02-Sep-21

Meeting Subject: - Osino Twin Hills Gold Mine Public Meeting

Venue: Karibib Town Hall @ 18:30

	NAME	ORGANIZATION	EMAIL ADDRESS	CONTACT NUMBER	SIGNATURE
1	Siegfried Gaisel	Community	s.gaisel@gmail.com	0813009892	<i>[Signature]</i>
2	Kaizer ICA	Community	kaizer@gmail.com	0816864990	<i>[Signature]</i>
3	Mico Simembe	Community	Karibib	0818876941	<i>[Signature]</i>
4	Starh'o Kechere	Community	Karibib	0813270302	<i>[Signature]</i>
5					
6					
7					
8					
9					
10					
11					



✉ info@eccenvironmental.com  
 🌐 www.eccenvironmental.com  
 📞 +264812627872  
 📠 +264816531214



Date: 02-Sept-21

Meeting Attendance Register

Meeting Subject: Osino Twin Hills - Public Meeting

Venue: Karibib Town Hall @ 14:30

	NAME	ORGANIZATION	EMAIL ADDRESS	CONTACT NUMBER	SIGNATURE
1	CHRISWAAN	N/A	monalisachristian@icloud.com	081 2135 387	
2	ROBERT	Man on line investment cc	remtleni@gmail.com	0813377670	
3	Michael	N/A	—	0814378386	
4	Melvin K	OKR Navachab	Melvin.kasale@navachab.com.na	0818824377	
5	Vicky Bauleth	OKR Navachab	Katjivera. Kondjee@navachab.com.na	0817 555331	
6	Bianca Faelcher	Community	P.O. Box 67 Karibib	(064) 550109	
7	Aluis GAWUB	Ofim SingwTA	P.O. Box 50 Karibib	0816987989	
8	Bernhard Williams	TSOAXUebana	P.O. Box 50 Karibib	0812557107	
9	SARA ILAMI	KTC	ledmanager@karibibtown.na	+264 816270129	
10	Selma Nghifrodaka	KTC	town planner@karibib.na	081 2090733	
11	SHEVA PAULUS	KTC	paulus.sheva65@gmail.com	0815611545	

✉ info@eccenvironmental.com  
 🌐 www.eccenvironmental.com  
 📞 +264812627872  
 📠 +264816531214



Date: 02 - Sept - 21

Meeting Attendance Register

Meeting Subject: Osimo Twin Hills - Public Meeting  
 Venue: Karibis Town Hall @ 14:30

	NAME	ORGANIZATION	EMAIL ADDRESS	CONTACT NUMBER	SIGNATURE
1	RAYMOND JIUNONGUA	<del>DWINGEDA</del>	raymondjiunongua@gmail	0818478902	
2	Alexis Prebrlus	Argis Press	argis@city.ni.	0812565777	
3	Melody Gontes	K.T.C	melodygontes@gmail.com	0814025786	
4	Moses Hamase	MAWLR	Moses.Hamase@mr.gov.na	0812806435	
5	Seibeb Seibeb	own	Seibeb Seibeb@gmail	0812300762	
6	Sylvia Seibes	own	bantago@gmail.com	0814998011	
7	Hani Lead	FNB	ukoljw@fnb.com.na	0811563331	
8	Nantudhu			0813629800	
9	BENHARB_U	TRANSINA.A	Bix_56@hotmail.com	0812559107	
10					
11					

\*



✉ info@eccenvironmental.com  
 🌐 www.eccenvironmental.com  
 📞 +264812627872  
 📠 +264816531214



Date: 02-Sept-21

Meeting Attendance Register

Meeting Subject: - Doino Twin Hills - Public Meeting  
 Venue: Karibib Town Hall @ 14:30

	NAME	ORGANIZATION	EMAIL ADDRESS	CONTACT NUMBER	SIGNATURE
1	Sarafina Haipinga	MAWLR-Suk	Sarafina.Haipinga@mlr.gov.na	0812801411 0647402208	
2	Befriedt Au-khax	KARIBIB TC	sheoffice@karibibtown.org	0818828119	
3	Allenan Tunde	Doino	ptunde@esnr.gov.na	0811430505	
4	Ambrosus Maysi	Khan	ambrosusimaysh@aol.com	0818848624	
5	Henghali Xandre	Khan	xandrehenghali@gmail.com	0816103598	
6	Elfriede Ganges	Community	elfriedeganges@gmail.com	0812194656	
7	Wendy Bertha Awases	Community	awasesbertha@gmail.com	0812823334	
8	Page Kapupu	Comm.		0816937173	
9	A. HASEB.	AKR	Banda.haseb@gmail.com	0812129966	
10	P. Seibes	Community		0812517355	
11	Ulho	Kodo Dilling	ulho@kodobdilling.com	0811494941	

**STAKEHOLDER ENGAGEMENT ATTENDANCE REGISTER February 2022**

Venue: Karibib TC

Date: 7/2/2022

	Your name	Name of Organisation	Your Position	Email – Large clear letters please	Cell
1	DAVEY VAN NYK	KARIBIB Town Council	Mayor	diqvanwyk@gmail.com	0815643445
2	GERSON GEINGOB	KTC	CUR.	cllr-geingob@karibibtown.org	0814673048
3	Tvonne Mupetani	KTC	Finance Manager	Finance@karibibtown.org	064550076
4	L.G. Goresesh	KTC	CEO	goreseb@karibibtown.org	
5	Selma Nghifadika	KTC	Town planner	townplanner@karibibtown.org	08155006
6	Werner Schuckmann	Osino	Country Manager	w.schuckmann@osinoresources.com	0811279379
7	Auriol Ashby	Osino	Social Consultant	ashby@eacc.com	081 240 9678
8	Lukas Tauti Shiimi	Osino	Community Coordinator	l.shiimi@osinoresources.com	0813130434
9	Robert Zippies	Osino	Corp. Sustainability	r.zippies@osinoresources.com	+2782 8987137
10					
11					
12					



**STAKEHOLDER ENGAGEMENT ATTENDANCE REGISTER**

Venue: Evening shade

Date: 07 Feb 2022

	Your name	Name of Organisation	Your Position	Email – Large clear letters please	Cell
1	Taute Shiimi	OSino	ESG/stakeholder	lshiimi@osinoresources.com.na	0818180434
2	Robert Zippres	OSino	Corp. Sust.	<del>r2ippres@osinoresources.com</del> r2ippres@osinoresources.com	0828987137
3	FRIKIE ENGELS	ORA	CHAIRMAN ORA	fengels@iway.na	081 7655 636
4	Ohwene	ORA	Adv. member	oew@iway.na	0811295336
5	Jhmanuel	ORA	Secretary	jmanuel2022@protonmail.com	0811228141
6	C. Namuse		HR Counsellor		0814775959
7	A. RAYH		Coordinator	cornamuse@osinoresources.com	0819366418
8	Wendy Schuchman	OSino	Casey Noga		
9	Aurial Ashby	OSino	Consultant	ashby@oacc.com.na	081 240 9678
10					
11					
12					

**STAKEHOLDER ENGAGEMENT ATTENDANCE REGISTER**

Venue: Evening shade

Date: 07 Feb 2022

	Your name	Name of Organisation	Your Position	Email – Large clear letters please	Cell
1	Taute Shiimi	OSino	ESG/stakeholder	lshiimi@osinoresources.com.na	0818180434
2	Robert Zippres	OSino	Corp. Sust.	<del>r.zippres@osinoresources.com</del> r.zippres@osinoresources.com	0828987137
3	FRIKIE ENGELS	ORA	CHAIRMAN ORA	fengels@iway.na	081 7655 636
4	Ohwene	ORA	Ord. member	oew@iway.na	0811295336
5	Jhmanuel	ORA	Secretary	jmanuel2022@protonmail.com	0811228141
6	C. Namuse		HR Counsellor		0814775959
7	A. RAYON		Coordinator	cornowolf@eppm.com	0819366418
8	Wendy Schuchman	OSino	Casey Noga		
9	Aurial Ashby	OSino	Consultant	ashby@oacc.com.na	081 240 9678
10					
11					
12					

**STAKEHOLDER ENGAGEMENT ATTENDANCE REGISTER February 2022**

Venue: Navachab Mine

Date: 07/02/2022

	Your name	Name of Organisation	Your Position	Email – Large clear letters please	Cell
1	HILDEBRAND WILHELM	QKR	PROCESSING MANAGER	hildebrand.wilhelm@ <del>navachab</del> com.na	0811225242
2	Richard Geuens	QKR	Resident Engineer	Richard.Geuens@ <del>navachab</del> com.na	0811272707
3	Ingo Schneider	QKR	CFO	ingo.schneider@navachab	0811444477
4	George Botshwe	QKR	MM	george.botshwe@ <del>navachab</del> com.na	0811224888
5	Werner Schuckmann	OSINO	Community Manager	w.schuckmann@ <del>navachab</del> com.na	0811279379
6	Auriel Ashby	Osino - consultant		ashby@aacc.com.na	0812409678
7	Taute Shiimi	OSINO	ESG and Community aff	tshiimi@osinoresources.com.na	0813130484
8	Robert Zipplies	Osino	Corp. Sustainability	rzipplies@osinoresources.com.na	0828487137
9					
10					
11					
12					

STAKEHOLDER ENGAGEMENT ATTENDANCE REGISTER February 2022

Venue: Council Chamber

Date: 07/02/22

	Your name	Name of Organisation	Your Position	Email – Large clear letters please	Cell
1	Josef Harpinge	Municipality of Omaruru	Acting chief Executive officer	techmanager@omamuni.org.na	08123359569
2	Vicent KATHA	MAYOR	MAYOR		0812052099
3	Mangundu Sigboth	Municipality of Omaruru	Chairperson	sigbothmangundu@gmail.com	0814662106
4	Verelanda Iiteka	Omaruru Municipality	Technician: Water	water.tech@omamuni.org.na	0814831603
5	ALDO KATHA	" "	Councillor		0812344418
6	Roswitha Kaura	Municipality of Omaruru	Manager: HR, Corp & Comm. Ser	hrmanager@omamuni.org.na	0816261973
7	Mahandjara Kahuta	" "	Manager: Finance	finmanager@omamuni.org.na	081148121
8	Theresa Phillips	Municipality of Omaruru	CIIR	phillipustheresid@gmail.com	0815977854
9	MATHIAS KAHUTA	Municipality of Omaruru	CIIR	kahuta.m@telecom.na	0816379393
10	Rattel Sabania	Omaruru Mun	Housing & Property	property.off@omamuni.org.na rpsabania@gmail.com	0812359855
11	Auriol Ashby	Osino	Consultant	ashby@aacc.com.na	081 240 9678
12	Wes Schuckman	Osino	Country Manager	w.schuckman@osinoresources.com	0811249379

B. Ephaim K. Katjatenja

0813558997

katjatenjae@omamuni.org.na  
ekajatenja62@gmail.com

LOCAL Economic Development Officer.



STAKEHOLDER ENGAGEMENT ATTENDANCE REGISTER

Venue: Various in Omaruru locations

Date: 8/2/2022

	Your name	Name of Organisation	Your Position	Email - Large clear letters please	Cell
1	KANYETU DIAS	Shackdwellers Federation	Network Facilitator	Kanyetud@gmail.com	0816067716
2	Sylvia Kituatupira	Shackdwellers	Network	SKituatupira@gmail.com	0813955562
3	Dantago D Musa	Shackdwellers Federation	Member	dantagobdeenmusa@gmail.com	0816595161
4	Menesia Pensel	Shackdwellers	Network leader	N/A	0812199381
5	Thelma Tjibandi	Shackdwellers	Member	N/A	0817291056
6	Imaganda Kanner	Shackdwellers	Member	N/A	0814346820
7	Gideon Fortune	Shack dwellers	member	Gfortune510@gmail.com	0857234299
8	Menesia Googoses	Joy House Fun Day Centre	owner	googosesmenet@gmail.com	0816268271
9	Annetjie Goobas	MCEPESW	ACLO	annegobas29@gmail.com	0816066401
10	Kisethe Gaware	ERC - Omaruru	CAO	kgaware@erongar.gov.na	0812422749
11	ADAM NDAHALELE	Development Workshop <sup>DWN</sup>	Area Coordinator	a.ndahalele@dw-namibia.org	0813041143
12	Oija Tjiriange	DWN - OMARURU	ECD Coordinator - OMARURU	O.tjiriange@gmail.com	0814929972

**STAKEHOLDER ENGAGEMENT ATTENDANCE REGISTER**

Venue: Karibib - USAB Community Hall

Date: 8/2/2022

	Your name	Name of Organisation	Your Position	Email - Large clear letters please	Cell
1	M. MBOME	USAB	Committee		0813231577
2	RAYMOND TOIYONGUA	Development Workshop	Admin Officer	Raymondtoiuyonga@gmail.com	0818478402
3	Norman Shidato	UIS Chairperson	Chair person	normanshidato@gmail.com	0813616592
4	Berta Mwula	UIS Committee	UIS Committe	Bertamwul@gmail.com	0813273057
5	ANDRIAS ANGUB	UIS Committe	UIS Committe	A. Anguba	
6	Ni Mwaha fa	NSDF Karibib	Chair person	mwahafakoddo@gmail.com	0812872600
7					
8					
9					
10					
11					
12					



✉ info@eccenvironmental.com  
 🌐 www.eccenvironmental.com  
 📞 +264812627872  
 📠 +264816531214



Meeting Attendance Register

Date: 10-02-2022

Meeting Subject: - Osino Meeting

Venue: Ministry of Environment, Forestry and Tourism

	NAME	ORGANIZATION	EMAIL ADDRESS	CONTACT NUMBER	SIGNATURE
1	Samuel Shimyamba	ECC	samuel@eccenvironmental.com	0814765261	
2	Werner Schuckmann	OSINO	w.schuckmann@osinoresources.com	0811279379	
3	Nelao Haimbili	MEFT	nelao.haimbili@yahoo.com	0813070501	
4	JOSAFAT K. HIWANA	MEFT	josafat.hiwana@meft.gov.na	0812444421	
5	Salmo Djaulume	MEFT	salmo.djaulume@meft.gov.na		
6	DAMIAN NCHINDO	MEFT	damián.nchindo2@meft.gov.na		
7	Ritika Shikongo	MEFT	ritika.shikongo@meft.gov.na	061-2842014	
8	Mwaka Lushetile	MEFT	mwaka.lushetile@meft.gov.na	061-2842811	
9	Johannes Hambia	MEFT	johannes.hambia@meft.gov.na	0812928801	
10	Edwin Daweti	OSINO	edaweti@osinoresources.com	0811254600	
11	Charles Creasy	OSINO	ccreasy@osinoresources.com	0817622209	
12					



## Names

1. Edward Umana Kangootui
2. Stephen Frindt B2 Gold
3. Mauno Sheehama
4. Winfried, ARrie Harupara
5. Immanuel Jipepa Okomoene was  
TRANSITIONAL Councillor: 0816517770

Thursday 17<sup>th</sup> Feb 2022  
Ondundu Visit

Stephen → No issues over the years  
B2gold helped with supplying the Community  
with masks during COVID  
- Helped with fixing

- Jipepa has some mining working experience  
in the mining industry having worked in  
a mine in Tsamab.



## STAKEHOLDER ENGAGEMENT ATTENDANCE REGISTER

Venue: Omanuru Police StationDate: 21/02/2022

Your Name	Name Of Organisation	Your Position	Email-Large clear letters please	Cell/Tel
E. Mumbala	Nampol	Inspector	MERICSON@nampol	0814371165
G. MUNIHANGO	Nampol Jeffie	Sergeant	Munihango9@gmail.com	0812046564
Joseph S	S F F	W/O		0812936870
S. NGHITTEKA	NAMPOL	DET. W. O/D	snghiteekak@gmail.com	0812689687
Jane Jiri Hoaks	Nampol	Cst.	pinajaneos@gmail.com	0818964802
N. A. Teofilus	Ciu Omanuru	O/WO <sup>2</sup>	nateofilus86@gmail.com	0813272505
R. Kazengurua	Admin Nampol	Admin Commander	rkazengurua8@gmail.com	0813217800

Sumbwanyambe  
Lucius Mahoto Correctional Service Training College



STAKEHOLDER ENGAGEMENT ATTENDANCE REGISTER

Venue:.....

Date: 23/02/2022

Your Name	Name Of Organisation	Your Position	Email-Large clear letters please	Cell/Tel
Consterencia Matheus	L.S. Mahoto Training College	Commandant	Consterencia.Matheus@ncs.gov.na	0813216949
HEINRICH IKA	NCS / COLLEGE	MAN. Dev. Training	Heinrich.ika@ncs.gov.na	0872792909
Jacobina Iyamba	L.S. Mahoto Training College	Secretary to the Commandant	Jacobina.Iyamba@ncs.gov.na	0813627367
Leslie N. Katito	L.S. Mahoto C.S. Training	Secretary	leslie.katito@ncs.gov.na	0812161607
Robert M. Kalonda	L.S. Mahoto C.S. Training	BASIC & CORRECTIONAL TRAINING	Robert.Kalonda@ncs.gov.na	0812922367
ERWIN AXAKHEB	L.S. Mahoto Training College	Head: Operational Support	Erwin.Axakheb@ncs.gov.na	0817880577
Immanuel Angelo	L.S. Mahoto CST college	Head: Complaints & Discipline	Immanuel.Angelo@ncs.gov.na	0812062627
DANIEL RUSBERG	L.S. Mahoto CST College	Staff officer: Operational support	rusbergdaniel@gmail.com	0812428282



REFERENCE: ECC-103-332-LET-21-A  
3rd December 2021

Office of the Environmental Commissioner  
Ministry of Environment Forestry and Tourism  
Private Bag 13306  
Windhoek  
Namibia

**RECEIVED BY OFFICIAL STAMP**

Received by Name:

Date:

Signature:

**FOR ATTENTION: ENVIRONMENTAL COMMISSIONER – MR TIMOTEUS MUFETI**

**COPY TO: CHIEF DEVELOPMENT PLANNER - MS SAIMA HANGULA  
HEAD OF IMPACT ASSESMENT - MR DAMIAN NCHINDO**

Dear Mr Timoteus Mufeti

**RE: REQUEST FOR MEETING WITH THE ENVIRONMENTAL COMMISSIONER.**

Environmental Compliance Consultancy (ECC) has been retained by Osino Gold Exploration and Mining (Pty) Ltd (OGEM), a Namibian company and subsidiary of Osino Resources Corp. to conduct an environmental and social impact assessment (ESIA) for the proposed mining of precious metals on Mining Licence 238 (ML 238), located near the town of Karibib, Erongo Region, Namibia.

Our team would like to request a meeting with the Environmental Commissioner and your officials to present the proposed project and the application for the environmental clearance certificate, and to avail the client for any questions you may have. The project has undergone an initial round of detailed public consultation which has been well received. The draft scoping report has been prepared, is currently out for public review, and has been submitted to your office and the competent authority for your review.

As the client will need to travel to be physically present for the meeting the following dates are proposed:

- Tuesday 7<sup>th</sup> December through to Friday 10<sup>th</sup> December 2021 or
- Monday 13<sup>th</sup> December through to Friday 17<sup>th</sup> December 2021.

Alternatively a virtual meeting can be arranged at your earliest convenience.

We look forward to hearing from you.

Yours sincerely,



Stephan Bezuidenhout  
Environmental Compliance Consultancy  
Office: +264 81 669 7608  
Email: [stephan@eccenvironmental.com](mailto:stephan@eccenvironmental.com)



Jessica Bezuidenhout Mooney  
Environmental Compliance Consultancy  
Office: +264 81 669 7608  
Email: [jessica@eccenvironmental.com](mailto:jessica@eccenvironmental.com)

Reply Reply all Forward Archive Delete Set flag ...

**ECC-103-332 Notice of public review period of the draft environmental and social scoping report for the proposed Osino Twin Hills Gold project, Karibib.**

 **Mariska Kuschke** <[info@eccenvironmental.com](mailto:info@eccenvironmental.com)>  
12/2/2021 10:13 AM

Tc: Jessica Mooney; monique@eccenvironmental.com Bcc: hdaun@osinoresources.com; ccreasy@osinoresources.com; mar1@africaonline.com.na; timwaen@gmail.com; sydney.theron@rst.com.na; Kandara.Mukusuka@nampower.com.na; admin@n-c-e.org; gerladinen@gmail.com; thasheela@mme.gov.na; vmalango@chamberofmines.org.na; ambrosiusmarsh@outlook; pr@rent-a-drum.com.na; cm@rent-a-drum.com.na; raymondtjiuongua@gmail.com; Tantago08@gmail.com; elfridegaingos@gmail.com; awasesbertha@gmail.com; mclyn.kasale@navachab.com.na; remtileni@gmail.com; mbangoleon@gmail.com; ndapandularoxie@gmail.com; info@khanriver.com.na; hedidehoffmann@gmax.net; timoteus.mufeti@met.gov.na; info@mme.gov.na; Erasmus.Shivolo@mme.gov.na; Anna.Gideon@mme.gov.na; cro@erongorc.gov.na; kalom@mawrd.gov.na; pa2ceo@karibibtown.org; info@n-c-e.org; info@chamberofmines.org.na; ombudeli@africaonline.com.na; imbusch@hotmail.co.uk; doris@hemconamibia.com; info@nhc-nam.org; erica@nhc-nam.org; rh01@nhc-nam.org; hilke@iway.na; wilz.lungu@yahoo.com; binkivdwest@gmail.com; goreseb@karibibtown.org; oigroup46@gmail.com; ambrosiusmarsh@outlook.com

Dear Interested and Affected Party,

Environmental Compliance Consultancy (ECC) has been contracted by Osino Gold Exploration and Mining (Pty) Ltd. (OGEM), a Namibian company and subsidiary of Osino Resources Corp., to undertake an environmental and social impact assessment (ESIA). OGEM manages operations in Namibia as a wholly owned subsidiary of Osino Namibia Holdings (Pty) Ltd. which is in turn a subsidiary of Osino Resources Corp. ECC is conducting an ESIA for the proposed mining of precious metals on Mining Licence 238 (ML 238), located near the town of Karibib, Erongo Region, Namibia.

ECC would hereby like to inform you, that the draft scoping report is now available for public review, affording a review period from the 1<sup>st</sup> of December 2021 to the 10<sup>th</sup> of December, in accordance with the Environmental Management Act (EMA), No. 7 of 2007 and its regulations of 2012.

All the relevant comments and concerns received from stakeholders during the public consultation period will be recorded and addressed in the updated reports that will be prepared for government submission. The draft report can be accessed on our website via the link:

<https://eccenvironmental.com/download/twin-hills-gold-project-near-karibib/>

We kindly request that you provide us with your review and commentary by the 10th of December 2021, via email at [info@eccenvironmental.com](mailto:info@eccenvironmental.com).

Should you require any further information, please do not hesitate to contact us.

Thank you on behalf of the ECC team,

**Environmental Compliance Consultancy (ECC)**

Office Tel: +264 81 669 7608  
Postal: PO BOX 91193 | Klein Windhoek | Namibia  
Address: 1 Jan Jonker St | Wasserberg Park | Klein Windhoek | Namibia  
Email: [info@eccenvironmental.com](mailto:info@eccenvironmental.com)  
Website: [www.eccenvironmental.com](http://www.eccenvironmental.com)





## ECC-103-332 Notice of public review period of the draft environmental impact assessment report for the proposed Osino Twin Hills Gold project, Karibib.



info ecc <[info@eccenvironmental.com](mailto:info@eccenvironmental.com)>

2/23/2022 8:04 PM

Bcc: Sarafina.Haipinge@mlr.gov.na; Veston Malango; mar1@africaonline.com.na; timwaen@gmail.com; sydney.theron@rst.com.na; Kandara.Mukusuka@nampower.com.na; admin@n-c-e.org; gerladinen@gmail.com; thasheela@mme.gov.na; ambrosiusmarsh@outlook.com; pr@rent-a-drum.com.na; cm@rent-a-drum.com.na; raymondtjiuongua@gmail.com; Tantago08@gmail.com; elfridegaingos@gmail.com; awasesbertha@gmail.com; mclyn.kasale@navachab.com.na; remtileni@gmail.com; mbangoleon@gmail.com; ndapandularoxie@gmail.com; info@khanriver.com.na; hedidehoffmann@gmax.net; timoteus.mufeti@met.gov.na; info@mme.gov.na; Erasmus.Shivolo@mme.gov.na; Anna.Gideon@mme.gov.na; cro@erongorc.gov.na; kalom@mawrd.gov.na; pa2ceo@karibibtown.org; info@n-c-e.org; [info@chamberofmines.org.na](mailto:info@chamberofmines.org.na); ombudeli@africaonline.com.na; imbusch@hotmail.co.uk; doris@hemconamibia.com; info@nhc-nam.org; erica@nhc-nam.org; rh01@nhc-nam.org; hilke@iway.na; wilz.lungu@yahoo.com; binkivdwest@gmail.com; goreseb@karibibtown.org; oigroup46@gmail.com; samuelshinyemba3@gmail.com; Moses.Hamaseb@mlr.gov.na; melodygontes@gmail.com; ledmanage@karibibtown.org; Labradornina09@gmail.com; heidehoffmann@gmax.net; arnowolf@yahoo.com; Abedkatonua463@gmail.com; Angis; anton.kandandu@navachab.com.na; Bandahaseb@gmail.com; bdnauoab@gmail.com; cllr-geingob@karibibtown.org; Francoiselvis87@gmail.com; ftunell@osinoresources.com; Grant Van der Merwe; igontes76@gmail.com; karibib@fpdt.na; Katjivena.Kondjee@navachab.com.na; kalindu@gmail.com; miindombo1@gmail.com; Mikepinias@gmail.com; monalisacghristiaan@icloud.com; namibiatrophy@gmail.com; neema940@gmail.com; paulus.sheya@karibibtown.org; piet@eccenvironmental.com; Richard.Manyanga@navachab.com; s.gariseb@gmail.com; SeibebSydney@gmail.com; sheofficer@karibibtown.org; shipenaempire@gmail.com; skandiwapa81@gmail.com; stepheneytheron@yahoo.com; Tjuwa93@gmail.com; tndevaetela@gmail.com; townplanner@karibibtown.org; vilho@kododrilling.com; uasorau@gmail.com; Ukatjivena@fnbnamibia.com; wslabbert@osinoresources.com; XandreHenghali@gmail.com; staines@afol.com.na; ccreasy@osinoresources.com; hdaun@osinoresources.com; rzipplies@osinoresources.com; edaweti@osinoresources.com; wschuckmann@osinoresources.com; Beat Weber; Bix\_56@hotmail.com; manfam@iafrica.com.na; Vanessa Stein; shimwanditoini@gmail.com; peterbeck@manx.net; wilsonlungu@protonmail.com; john-paul.mubita@mme.gov.na; theo@burmeister.com.na; ndiwakalungamaija7@gmail.com; roald@giconstruction.net; Philip Hooks; Matthew Bliss; Lester Harker; monique@eccenvironmental.com; Mariska Kuschke; Jessica Mooney; Stephan Bezuidenhout;



ECC-103-332 Notice of public review period of the draft environmental impact assessment report for the proposed Osino Twin Hills Gold project, Karibib. Inbox x



**info ecc** <info@eccenvironmental.com>  
to bcc: me

Wed, 23 Feb, 20:05 (13 days ago) ☆ ↶ ⋮

Dear Interested and Affected Party,

**RE: Notice of public review period of the draft environmental impact assessment report for the proposed Osino Twin Hills Gold project, Karibib.**

This is a courtesy email to inform you that the draft environmental impact assessment report for the proposed Osino Twin Hills Gold project, near Karibib, is available for your review. The draft report can be accessed on our website via the link:

<https://eccenvironmental.com/download/twin-hills-gold-project-karibib/>

The review period on the draft environmental impact assessment report is open until the 8<sup>th</sup> of March 2022. All comments and concerns received from stakeholders during the public review period will be recorded and addressed in the updated reports that will be prepared for government submission.

We kindly request that you provide us with your review and commentary by the 8<sup>th</sup> of March 2022, via email at [info@eccenvironmental.com](mailto:info@eccenvironmental.com)

Should you require any further information, please do not hesitate to contact us.

Thank you on behalf of the ECC team,

--

**Environmental Compliance Consultancy (ECC)**

Office Tel: +264 81 869 7608  
Postal: PO BOX 91193 | Klein Windhoek | Namibia  
Address: 1, Jan Jonker St | Wasserberg Park | Klein Windhoek | Namibia  
Email: [info@eccenvironmental.com](mailto:info@eccenvironmental.com)  
Website: [www.eccenvironmental.com](http://www.eccenvironmental.com)





**COPY**



REFERENCE: ECC-103-332-LET-25-A  
2 December 2021

Ministry of Mines and Energy  
Private Bag 13297  
Windhoek  
Namibia

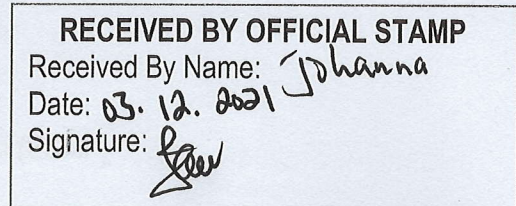

**FOR ATTENTION: MME EXECUTIVE DIRECTOR (MR. SIMEON NIILENGE NEGUMBO)**

**COPY TO:** Mr. Timoteus Mufeti (Ministry of Environment, Forestry and Tourism – Environmental Commissioner)  
Mr. Erasmus Shivolo (Ministry of Mines and Energy – Mining Commissioner)

Dear Mr. Simeon Niilenge Negumbo,

**RE: SUBMISSION OF THE DRAFT SCOPING REPORT AND ESMP FOR THE APPLICATION FOR ENVIRONMENTAL CLEARANCE CERTIFICATE FOR THE OSINO TWIN HILL GOLD PROJECT FOR OSINO GOLD EXPLORATION AND MINING (PTY) LTD IN THE ERONGO REGION, NAMIBIA.**

Environmental Compliance Consultancy (ECC) is the appointed environmental assessment practitioner for the proposed Twin Hills Gold Project, proposed by the proponent Osino Gold Exploration and Mining (Pty) Ltd. ECC is conducting an environmental and social impact assessment for the proposed mining activities for precious metals in the Karibib District, Erongo Region, Namibia.

In terms of Section 32 (1) of the Environmental Management Act, No. 7 of 2007, ECC has determined that the Ministry of Mines and Energy (MME) is the competent authority for the proposed project, as mining activity trigger listed activities as per the Environmental Management Act Regulations.

The draft environmental and social impact assessment scoping report and preliminary environmental management plan is undergoing a period of public review from 1<sup>st</sup> – 10<sup>th</sup> December. Feedback from the



public review period will be incorporated in the updated reports which will be submitted to your office for review and record of decision.

ECC hereby submits the attached documents for your review:

- Draft environmental and social scoping report
- Preliminary draft environmental and social management plan (ESMP)

Should you or your office require our assistance with the details contained within this letter or any project specific details, please do not hesitate to contact us and we will gladly assist.

We look forward to hearing from you at your earliest convenience.

Yours sincerely,



Stephan Bezuidenhout  
**Environmental Compliance Consultancy**  
**Contact:** +264 81 669 7608  
**Email:** stephan@eccenvironmental.com

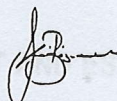

Jessica Bezuidenhout Mooney  
**Environmental Compliance Consultancy**  
**Contact:** +264 81 669 7608  
**Email:** jessica@eccenvironmental.com







COPY

+264 81 669 7608

info@eccenvironmental.com

www.eccenvironmental.com

REFERENCE: ECC-103-332-LET-5-A

18 August 2021

Ministry of Mines and Energy  
Private Bag 13297  
Windhoek  
Namibia



**FOR ATTENTION: MME EXECUTIVE DIRECTOR (MR. SIMEON NIILENGE NEGUMBO)**

**COPY TO:** Mr. Timoteus Mufeti (Ministry of Environment, Forestry and Tourism – Environmental Commissioner)  
Mr. Erasmus Shivolo (Ministry of Mines and Energy – Mining Commissioner)

Dear Mr. Simeon Niilenge Negumbo,

**RE: REGISTRATION OF THE APPLICATION FOR ENVIRONMENTAL CLEARANCE CERTIFICATE FOR OSINO GOLD EXPLORATION AND MINING (PTY) LTD TO UNDERTAKE MINING ACTIVITIES FOR BASE AND RARE METALS, PRECIOUS METALS IN THE KARIBIB DISTRICT, ERONGO REGION, NAMIBIA.**

Environmental Compliance Consultancy (ECC) has been appointed by Osino Resources Corp. and Osino Namibia Holdings (Pty) Ltd (Holding company of Osino Gold Exploration and Mining (Pty) Ltd) to act on their behalf for the environmental clearance certificate application for the proposed mining activities for base and rare metals, and precious metals in the Karibib District, Erongo Region, Namibia.

Osino Gold Exploration and Mining (Pty) Ltd (The proponent and applicant), a Namibian registered company, proposes to undertake mining activities to process base and rare metals, and/or precious metals, and in particular gold. Previous exploration activities have identified extensive gold mineralization, defined precious metals reserves and resources (especially gold) and extensive development studies which have culminated in a feasibility study and economic analysis for the project, referred to as the Twin Hills Gold Project ("Twin Hills" or "the Project"). Twin Hills is proposed as a conventional truck & shovel open-pit with carbon-in-leach metallurgical processing route which is very similar to the other two gold mines in Namibia, Otjikoto and Navachab. The Twin Hills Gold Project comprises numerous EPL's is rapidly being fast-tracked to development. An important next step is the application for a mining license which will secure the licensing position and tenure of the project,



thereby enabling Osino to continue to develop the project into an operational, large-scale gold mine. The planned project involves developing the current exploration activities on EPLs 5196, 6167, 5658, 6953, 3739 and 7301 into full scale gold mining operation.

In terms of Section 32 (1) of the Environmental Management Act, No. 7 of 2007, ECC has determined that the Ministry of Mines and Energy (MME) is the competent authority for the proposed mining project. The mining activity triggers the listed activities as per the Environmental Management Act Regulations. The relevant list is contained in the attached Background Information Document (BID).

Due to the nature of the proposed project, the potential impacts on the environment and society, ECC is undertaking an Environmental and Social Impact Assessment (ESIA) for the application for environmental clearance.

ECC hereby submits the attached registration documents for your notification:

- **FORM 1 (ATTACHED)** – Environmental Management Act, No. 7 of 2007, section 32 Application Environmental Clearance Certificate
- **ESIA PROJECT BID**

Should you or your office require our assistance with the details contained within this letter or any project specific details, please do not hesitate to contact us and we will gladly assist.

We look forward to hearing from you at your earliest convenience.

Yours sincerely,

Stephan Bezuidenhout  
Environmental Compliance Consultancy  
Contact: +264 81 669 7608  
Email: [stephan@eccenvironmental.com](mailto:stephan@eccenvironmental.com)

Jessica Bezuidenhout Mooney  
Environmental Compliance Consultancy  
Contact: +264 81 669 7608  
Email: [jessica@eccenvironmental.com](mailto:jessica@eccenvironmental.com)



COPY



MINISTRY OF ENVIRONMENT,  
FORESTRY AND TOURISM  
DIRECTORATE OF ENVIRONMENTAL AFFAIRS  
23 AUG 2021  
RECEIVED 1  
Signature: *Clarep dhs* info@eccenvironmental.com

+264 81 669 7608

www.eccenvironmental.com



Stamped Received By:

<p>Ministry of Mines and Energy:</p>	<p><b>RECEIVED BY OFFICIAL STAMP</b>          Received by Name: 2021-08-23          Date:          Signature: <i>NR</i></p>
<p>Ministry of Environment, Forestry and Tourism:</p>	<p><b>RECEIVED BY OFFICIAL STAMP</b>          Received by Name:          Date:          Signature:</p>
<p>Ministry of Agriculture, Water and Land Reform:</p>	<p><b>RECEIVED BY OFFICIAL STAMP</b>          Received by Name:          Date: 2021-08-23          Signature:          EXECUTIVE DIRECTOR'S OFFICE          MAWLR</p>

REFERENCE: ECC-103-332-LET-17-A  
20<sup>th</sup> August 2021

Dear Identified Stakeholder and or Potentially Interested Party:

**RE: INVITATION TO A PUBLIC MEETING FOR THE OSINO RESOURCES' TWIN HILLS GOLD MINE PROJECT, KARIBIB DISTRICT IN THE ERONGO REGION.**

Environmental Compliance Consultancy (ECC) on behalf of our client Osino Gold Exploration and Mining (Pty) Ltd hereby notifies you of the upcoming public meetings. ECC is conducting an environmental impact assessment in accordance with the Environmental Management Act, No. 7 of 2007, for which an application for an environmental clearance certificate will be submitted for gold mining in the Erongo Region.





The proposed project will entail open pit mining by conventional drill & blast, load & haul with a fleet of mobile mining equipment. Gold bearing ore will be processed by crushing, cyanide leaching, carbon-in-pulp (CIP) processing, electrowinning and then smelting in an induction furnace to produce gold bars.

This letter is intended to invite and engage stakeholders and potentially Interested and Affected Parties (I&APs) of the proposed project and provide a communication channel with the members of the public and Competent Authorities. You have been identified as either a stakeholder/ I&AP, and therefore ECC wishes to invite you to register and attend the first round of public meetings and provide input to the environmental and social impact assessment (ESIA). Details are provided below:

**Public Meetings:**

**Windhoek, Tuesday, 31st August 2021**

Address: 110 Robert Mugabe Avenue, Windhoek

- |                    |  |
|--------------------|--|
| 1. First Meeting:  | <b>14:30 at the Scientific Society</b> |
| 2. Second Meeting: | <b>18:30 at the Scientific Society</b> |

**Omaruru, Wednesday, 1st September 2021**

Address: Wilhelm Zeraua Rd, Omaruru

- |                    |                                   |
|--------------------|-----------------------------------|
| 3. First Meeting:  | <b>14:30 at the Central Hotel</b> |
| 4. Second Meeting: | <b>18:30 at the Central Hotel</b> |

**Karibib, Thursday, 2<sup>nd</sup> September 2021**

Address: 19 Kalk Street, Karibib

- |                    |                                   |
|--------------------|-----------------------------------|
| 5. First Meeting:  | <b>14:30 at Karibib Town Hall</b> |
| 6. Second Meeting: | <b>18:30 at Karibib Town Hall</b> |

Public participation is an important part of the ESIA process, as it allows the public to obtain information about the proposed project. Public participation occurs at various stages throughout a project lifecycle:

1. Please **register as an IAP**
2. Register for the project at: <https://eccenvironmental.com/projects/> or call ECC to register and If you are unable to complete the registration form online please email [info@eccenvironmental.com](mailto:info@eccenvironmental.com) and request an electronic copy of



the form that you can complete, sign, scan and return via email to [info@eccenvironmental.com](mailto:info@eccenvironmental.com) to register as an I&AP for the project.

3. Registered I&APs will receive a project Background Information Document (BID).
4. Registered I&APs will also be notified of the draft scoping report for a 7 days comment and review period, once available. During this period the public will have the opportunity to review the draft document and raise any issues or concerns

The closing date to receive written comments and or concerns will be the 24th September 2021.

In addition to the above meetings, Osino Gold Exploration and Mining (Pty) Ltd are committed to engaging all affected stakeholders through planned, ongoing public participation in the form of focus groups and further meetings as required.

**Please RSVP through any of the channels provided and confirm your attendance for the public meeting at your most suitable venue, as per the above listed.**

ECCs values community input and participation in our projects and we look forward to working with you as the project develops. Should you require further information, please do not hesitate to contact us.

Yours sincerely,



Stephan Bezuidenhout  
**Environmental Compliance Consultancy**  
Contact: 081 669 7608  
Email: [stephan@eccenvironmental.com](mailto:stephan@eccenvironmental.com)



Jessica Bezuidenhout Mooney  
**Environmental Compliance Consultancy**  
Contact: 081 669 7608  
Email: [jessica@eccenvironmental.com](mailto:jessica@eccenvironmental.com)

ENVIRONMENTAL COMPLIANCE CONSULTANCY  
CC/2013/11404



23 AUG 2021

ENVIRONMENTAL  
COMPLIANCE CONSULTANCY

ENVIRONMENTAL COMPLIANCE CONSULTANCY CC  
PO BOX 91193 WINDHOEK, NAMIBIA  
MEMBERS: J L MOONEY & JS BEZUIDENHOUT  
REGISTRATION NUMBER: CC/2013/11404

[eccenvironmental.com](http://eccenvironmental.com)



**COPY**

+264 81 669 7608

info@eccenvironmental.com

www.eccenvironmental.com



REFERENCE: ECC-103-332-LET-26-A  
22 December 2021

Office of the Executive Director  
Ministry of Mines and Energy  
Private Bag 13297  
Windhoek  
Namibia

<b>RECEIVED BY OFFICIAL STAMP</b> Received by Name: Date: Signature:	<b>MINISTRY OF ENVIRONMENT, FORESTRY AND TOURISM</b> DIRECTORATE OF ENVIRONMENTAL AFFAIRS <b>22 DEC 2021</b> Tel: 061 284 2701 RECEIVED 2
	Signature:.....

**FOR ATTENTION: MME EXECUTIVE DIRECTOR (MR SIMEON NIILENGE NEGUMBO)**

**COPY TO:** Mr Timoteus Mufeti (Ministry of Environment, Forestry and Tourism – Environmental Commissioner)  
Mr Erasmus Shivolo (Ministry of Mines and Energy – Mining Commissioner)

Dear Mr Simeon Niilenge Negumbo,

**RE: SUBMISSION OF THE FINAL SCOPING REPORT AND ESMP FOR THE APPLICATION FOR THE ENVIRONMENTAL CLEARANCE CERTIFICATE FOR THE OSINO TWIN HILL GOLD PROJECT FOR OSINO GOLD EXPLORATION AND MINING (PTY) IN THE ERONGO REGION, NAMIBIA.**

Environmental Compliance Consultancy (ECC) is the appointed environmental assessment practitioner for the proposed Twin Hills Gold Project, proposed by the proponent Osino Gold Exploration and Mining (Pty) Ltd. ECC is conducting an environmental and social impact assessment for the proposed mining activities for precious metals in the Karibib District, Erongo Region, Namibia.

In terms of Section 32 (1) of the Environmental Management Act, No. 7 of 2007, ECC has determined that the Ministry of Mines and Energy (MME) is the competent authority for the proposed project, as mining activity trigger listed activities as per the Environmental Management Act and its regulations.

The draft scoping report for the Twin Hills Gold Project was submitted to your offices for review on the 1st of December 2021. Furthermore, it has undergone a public review period from 1 through to 21 December (20 days), exceeding the minimum 7 days as per the regulations.

As the next step in the process, we are submitting the following documents to your office for review and record of decision.

- Final environmental and social scoping report
- Final environmental and social management plan (ESMP)

We are now undertaking the assessment section of the ESIA with the aim to submit the assessment report to your office in February 2022.

Should you or your office require our assistance with the details contained within this letter or any project specific details, please do not hesitate to contact us and we will gladly assist

We look forward to hearing from you.

Yours sincerely,



Stephan Bezuidenhout  
**Environmental Compliance Consultancy**  
**Office: +264 81 669 7608**  
Email: [stephan@eccenvironmental.com](mailto:stephan@eccenvironmental.com)



Jessica Bezuidenhout Mooney  
**Environmental Compliance Consultancy**  
**Office: +264 81 669 7608**  
Email: [jessica@eccenvironmental.com](mailto:jessica@eccenvironmental.com)







**COPY**

REFERENCE: ECC-103-332-LET-26-A  
22 December 2021

Office of the Executive Director  
Ministry of Mines and Energy  
Private Bag 13297  
Windhoek  
Namibia

<b>RECEIVED BY OFFICIAL STAMP</b>
Received by Name: <i>Matthiele</i>
Date: <i>22.12.2021</i>
Signature: <i>W. Huiper</i>

MINISTRY OF MINES AND ENERGY  
OFFICE OF THE EXECUTIVE DIRECTOR  
2021-12-22  
RECEIVED

**FOR ATTENTION: MME EXECUTIVE DIRECTOR (MR SIMEON NIILENGE NEGUMBO)**

**COPY TO:** Mr Timoteus Mufeti (Ministry of Environment, Forestry and Tourism - Environmental Commissioner)  
Mr Erasmus Shivolo (Ministry of Mines and Energy - Mining Commissioner)

Dear Mr Simeon Niilenge Negumbo,

**RE: SUBMISSION OF THE FINAL SCOPING REPORT AND ESMP FOR THE APPLICATION FOR THE ENVIRONMENTAL CLEARANCE CERTIFICATE FOR THE OSINO TWIN HILL GOLD PROJECT FOR OSINO GOLD EXPLORATION AND MINING (PTY) IN THE ERONGO REGION, NAMIBIA.**

Environmental Compliance Consultancy (ECC) is the appointed environmental assessment practitioner for the proposed Twin Hills Gold Project, proposed by the proponent Osino Gold Exploration and Mining (Pty) Ltd. ECC is conducting an environmental and social impact assessment for the proposed mining activities for precious metals in the Karibib District, Erongo Region, Namibia.

In terms of Section 32 (1) of the Environmental Management Act, No. 7 of 2007, ECC has determined that the Ministry of Mines and Energy (MME) is the competent authority for the proposed project, as mining activity trigger listed activities as per the Environmental Management Act and its regulations.



The draft scoping report for the Twin Hills Gold Project was submitted to your offices for review on the 1st of December 2021. Furthermore, it has undergone a public review period from 1 through to 21 December (20 days), exceeding the minimum 7 days as per the regulations.

As the next step in the process, we are submitting the following documents to your office for review and record of decision.

- Final environmental and social scoping report
- Final environmental and social management plan (ESMP)

We are now undertaking the assessment section of the ESIA with the aim to submit the assessment report to your office in February 2022.

Should you or your office require our assistance with the details contained within this letter or any project specific details, please do not hesitate to contact us and we will gladly assist

We look forward to hearing from you.

Yours sincerely,



Stephan Bezuidenhout  
**Environmental Compliance Consultancy**  
**Office: +264 81 669 7608**  
Email: [stephan@eccenvironmental.com](mailto:stephan@eccenvironmental.com)



Jessica Bezuidenhout Mooney  
**Environmental Compliance Consultancy**  
**Office: +264 81 669 7608**  
Email: [jessica@eccenvironmental.com](mailto:jessica@eccenvironmental.com)





The National Heritage Council  
Ministry of Education, Arts and Culture  
Private Bag 13236  
Windhoek  
Namibia

**RECEIVED BY OFFICIAL STAMP**  
Received by Name: *Bewesley van Wyk*  
Date: *21/02/2022*  
Signature: *[Handwritten Signature]*

Dear Erica Ndalikokule,

**RE: MEETING REQUEST ON BEHALF OF OSINO GOLD EXPLORATION AND MINING (PTY) LTD FOR THE TWIN HILLS GOLD PROJECT IN THE ERONGO REGION, NAMIBIA**

Environmental Compliance Consultancy (ECC) writes on behalf of our client to request a meeting with the National Heritage Council (NHC) to introduce the findings of the heritage assessment that was conducted as part of the environmental and social impact assessment for the proposed Project.

**Background and context**

The proposed Twin Hills Gold Project (referred to as the Project herein) is planned to be a conventional open pit gold mine with a gold extraction process similar to those in existing gold mines in Namibia, such as the Otjikoto and Navachab mines. An archaeological field survey and assessment was carried out on the Twin Hills Gold Project site as part of the ESIA process. Several archaeological sites were located, see Figure 1, as assessed by Dr John Kinahan (2021).

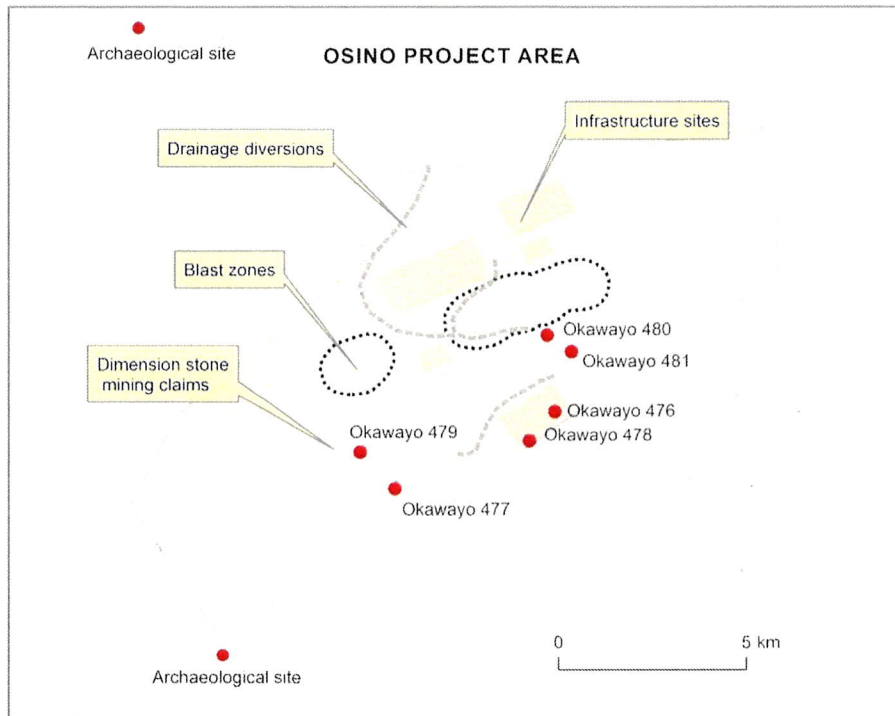

**Figure 1 - A map showing the location of archaeological sites**

Archaeology has been studied in the areas surrounding the Erongo mountains, 20km to the northwest of the site, but no previous work has been completed at Okawayo itself. The field survey discovered several precolonial sites resembling historical Ovaherero settlements on the south side of the marble ridge, outside of the proposed Project area, but in proximity to the current dimension stone quarrying activities. The archaeological report shows the presence of colonial sites on the site, but no precolonial features on the project site itself.

The scoping report, EMP and all specialist studies developed for the Project was circulated for public review in 2021. The full draft impact assessment is now available for public review during the period of 22 February 2022 – 8 March 2022. Therefore, we provide a full hard copy to your office for ease of review.

The ruined colonial building on site will be affected by the project, as stated in the assessment. Therefore, the proponent will need to commence discussions with your office regarding the perseveration and or relocation of key elements of the old ruins and initiate any heritage permit applications required by your office.

As such we would like to request a meeting with your office preferably next week (28<sup>th</sup> February – 4<sup>th</sup> March) allowing time for your review of the documentation this week, to have a fruitful meeting so that the way forward can be discussed.

Should you or your office require our assistance with the details contained within this letter or any project specific details, please do not hesitate to contact us and we will gladly assist.

Yours sincerely,



**Stephan Bezuidenhout**  
Environmental Compliance Consultancy  
Office: +264 81 669 7608  
Email: stephan@eccenvironmental.com



**Jessica Bezuidenhout (Mooney)**  
Environmental Compliance Consultancy  
Office: +264 81 669 7608  
Email: jessica@eccenvironmental.com





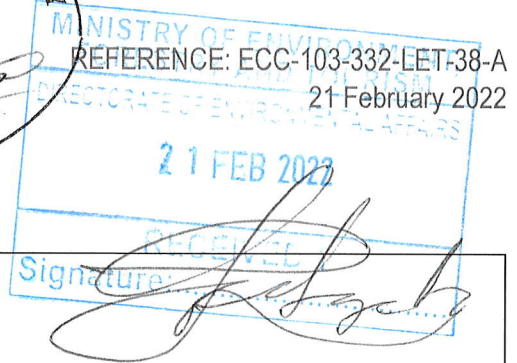
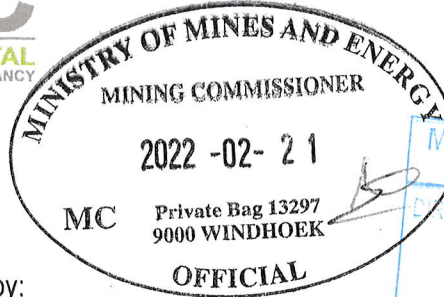

Stamped and received by:

<u>Ministry of Mines and Energy:</u>	
<u>Ministry of Environment, Forestry and Tourism</u>	
<u>National Heritage Council</u>	<i>Bwedey van Wilk 21 February 2022.</i>

Office of the Executive Director  
Ministry of Mines and Energy  
Private Bag 13297  
Windhoek  
Namibia

**FOR ATTENTION: MME EXECUTIVE DIRECTOR (MR SIMEON NIILENGE NEGUMBO)**

**COPY TO:** Mr Timoteus Mufeti (Ministry of Environment, Forestry and Tourism)  
Environmental Commissioner)  
Mr Erasmus Shivolo (Ministry of Mines and Energy – Mining Commissioner  
Mrs Erica Ndalikokule (National Heritage Council) – Heritage Management

Dear Mr Simeon Niilenge Negumbo,

**RE: SUBMISSION OF THE DRAFT SCOPING REPORT AND EMP FOR THE APPLICATION OF THE ENVIRONMENTAL CLEARANCE CERTIFICATE FOR THE OSINO TWIN HILL GOLD PROJECT FOR OSINO GOLD EXPLORATION AND MINING (PTY) IN THE ERONGO REGION, NAMIBIA.**



Environmental Compliance Consultancy (ECC) has been engaged by Osino Gold Mining Namibia (Pty) Ltd, the proponent, to conduct an environmental and social impact assessment for the proposed Twin Hills Gold project on Mining Licence 238 (ML 238) in the Karibib District, Erongo Region, Namibia.

In terms of Section 32 (1) of the Environmental Management Act (EMA), No. 7 of 2007, ECC submits the draft Twin Hills Gold Project impact assessment for your review.

The draft impact assessment is currently being circulated for public review to all I&APs and stakeholders for the period of 21 February – 8 March 2022. We kindly request that you revert to us with any comments during the period by email to [info@eccenvironmental.com](mailto:info@eccenvironmental.com)

A hard copy of the assessment plus appendices is enclosed, furthermore the reports can be accessed via our website: <https://eccenvironmental.com/download/twin-hills-gold-project-karibib/>

Should you or your office require our assistance with the details contained within this letter or any project specific details, please do not hesitate to contact us and we will gladly assist.

We look forward to hearing from you.

Yours sincerely,  
**Environmental Compliance Consultancy**



Stephan Bezuidenhout

**Contact:** +264 81 669 7608

Email: [stephan@eccenvironmental.com](mailto:stephan@eccenvironmental.com)



Jessica Bezuidenhout Mooney

**Contact:** +264 81 669 7608

Email: [jessica@eccenvironmental.com](mailto:jessica@eccenvironmental.com)

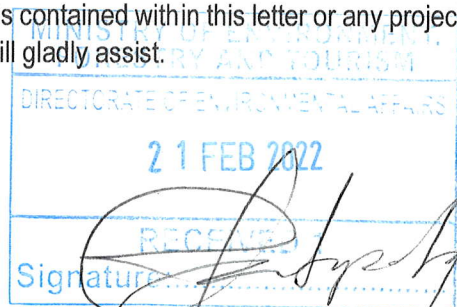

Documents hereto attached include:

- Draft ESIA for the Twin Hills Gold Project
- Appendix A – ESMP
- Appendix B – Public Consultation Records
- Appendix C – Noise Baseline Assessment
- Appendix D – Air Quality Baseline Assessment
- Appendix E – Water Baseline Studies
- Appendix F – Biodiversity Studies
- Appendix G – Archeological Baseline
- Appendix H – Traffic Impact Studies
- Appendix I – SocioEconomic Impact Assessment





MINISTRY OF ENVIRONMENT,  
FORESTRY AND TOURISM  
DIRECTORATE OF ENVIRONMENTAL AFFAIRS  
03 DEC 2021  
RECEIVED 1  
Signature: *[Handwritten Signature]*



**COPY**

REFERENCE: ECC-103-332-LET-25-A  
2 December 2021

Ministry of Mines and Energy  
Private Bag 13297  
Windhoek  
Namibia

**RECEIVED BY OFFICIAL STAMP**  
Received By Name:  
Date:  
Signature:

**FOR ATTENTION: MME EXECUTIVE DIRECTOR (MR. SIMEON NIILENGE NEGUMBO)**

**COPY TO:** Mr. Timoteus Mufeti (Ministry of Environment, Forestry and Tourism – Environmental Commissioner)  
Mr. Erasmus Shivolo (Ministry of Mines and Energy – Mining Commissioner)

Dear Mr. Simeon Niilenge Negumbo,

**RE: SUBMISSION OF THE DRAFT SCOPING REPORT AND ESMP FOR THE APPLICATION FOR ENVIRONMENTAL CLEARANCE CERTIFICATE FOR THE OSINO TWIN HILL GOLD PROJECT FOR OSINO GOLD EXPLORATION AND MINING (PTY) LTD IN THE ERONGO REGION, NAMIBIA.**

Environmental Compliance Consultancy (ECC) is the appointed environmental assessment practitioner for the proposed Twin Hills Gold Project, proposed by the proponent Osino Gold Exploration and Mining (Pty) Ltd. ECC is conducting an environmental and social impact assessment for the proposed mining activities for precious metals in the Karibib District, Erongo Region, Namibia.

In terms of Section 32 (1) of the Environmental Management Act, No. 7 of 2007, ECC has determined that the Ministry of Mines and Energy (MME) is the competent authority for the proposed project, as mining activity trigger listed activities as per the Environmental Management Act Regulations.

The draft environmental and social impact assessment scoping report and preliminary environmental management plan is undergoing a period of public review from 1<sup>st</sup> – 10<sup>th</sup> December. Feedback from the

public review period will be incorporated in the updated reports which will be submitted to your office for review and record of decision.

ECC hereby submits the attached documents for your review:

- Draft environmental and social scoping report
- Preliminary draft environmental and social management plan (ESMP)

Should you or your office require our assistance with the details contained within this letter or any project specific details, please do not hesitate to contact us and we will gladly assist.

We look forward to hearing from you at your earliest convenience.

Yours sincerely,



Stephan Bezuidenhout

**Environmental Compliance Consultancy**

**Contact:** +264 81 669 7608

Email: [stephan@eccenvironmental.com](mailto:stephan@eccenvironmental.com)



Jessica Bezuidenhout Mooney

**Environmental Compliance Consultancy**

**Contact:** +264 81 669 7608

Email: [jessica@eccenvironmental.com](mailto:jessica@eccenvironmental.com)

